

MEISTER

Cenník

MeisterDesign. laminate

2024

PREHĽAD KOLEKCIÍ

Kolekcia	Spoj	Vode- odolnosť	Záťaž	V - drážka	Balenie (m ²)	Hrúbka (mm)	Šírka (mm)	Dĺžka (mm)	EUR /m ² bez DPH	EUR /m ² s DPH
LS 350 ^{new}	UniZip	4 h	32	micro po celom obvode	1,552	10	168	840	36,25	43,50
LL 250	5G Dry	24 h	32	micro po celom obvode	2,036	10	248	2.052	31,76	38,12
LD 250	MultiClic	24 h	32	micro po celom obvode	1,886	10	244	1.288	27,18	32,62
LB 150	MultiClic	4 h	32	po celom obvode	2,388	8	398	857	25,16	30,20
LL 150	5G Dry	4 h	32	po celom obvode	2,709	8	220	2.052	25,16	30,20
LL 150 S	5G Dry	4 h	32	po celom obvode	2,257	10	220	2.052	30,20	36,24
LD 200 ^{new}	MultiClic	4 h	32	micro po celom obvode	2,514	8	244	1.288	22,14	26,57
LD 150	MultiClic	4 h	32	pozdĺžna/ pričná mikro	2,550	8	198	1.288	18,85	22,62
LC 150	MultiClic	4 h	32	bez	2,550	8	198	1.288	16,59	19,91

Kompletnú ponuku laminátových podláh MEISTER so všetkými kolekciami a dekormi vrátane príslušenstva nájdete na našich webových stránkach www.bausad.sk.



Diamond Pro® surface

Špeciálny povrch Diamond Pro ukazuje, že naša laminátová podlaha je odolná voči mikroškrabancom a oderu a poskytuje dodatočnú ochranu proti opotrebovaniu (okrem LC 55 | LC 55 S | LD 55).



Anti-static finish

Všetky laminátové podlahy MEISTER (okrem LC 55 | LC 55 S | LD 55) majú dodatočnú antistatickú úpravu. Tým sa minimalizuje vznik statickej elektriny u ľudí na < 2 kV a tým sa chráni proti množstvu výbojov na kovových predmetoch, napr. pri dotyku kľučky dverí.



AquaSafe system | AquaSafe+ system

Všetky laminátové podlahy MEISTER (okrem LC 55 | LC 55 S | LD 55) sú vodeodolné, pretože obsahujú komplexnú ochranu systémom AquaSafe alebo AquaSafe+ proti vlhkosti. Pozostáva z troch účinných prvkov, ktoré chránia podlahu pred akoukoľvek prenikajúcou vlhkosťou:

Povrchová ochrana
Povrch melamínovej živice je svojou povahou absolútne vodotesný.

Impregnácia hrán AquaStop a tesnosť spojov
Špeciálne vyvinutá a patentovaná geometria click profilu, ktorá pracuje s predpätím, spolu s impregnáciou hrán AquaStop zaručuje pevné a trvalé utesnenie profilu.

Základná doska proti napučaniu
Účinná základová doska proti napučovaniu dokáže do značnej miery zabrániť napučaniu v prípade kontaktu s vodou (4 hodiny ochrany pri stagnujúcej vlhkosti). Účinná základná doska proti napučaniu AquaSafe+ « poskytuje dokonca 24-hodinovú ochranu proti vlhkosti. »

Poznámka:

Predaj možný iba na ucelené balenia!

MeisterDesign. laminate - LS 350 **NOVINKA**

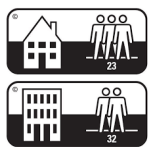

Kód produktu	Názov dekoru	Kompatibilná lišta	EUR /m ² bez DPH	EUR /m ² s DPH
600001-0840168-07001	Champagne oak 7001	06131		
600001-0840168-07002	Amber oak 7002	06392		
600001-0840168-07113	Pure relax oak 7113	06428	36,25	43,50
600001-0840168-07127	Honey riverbank oak 7127	07127		

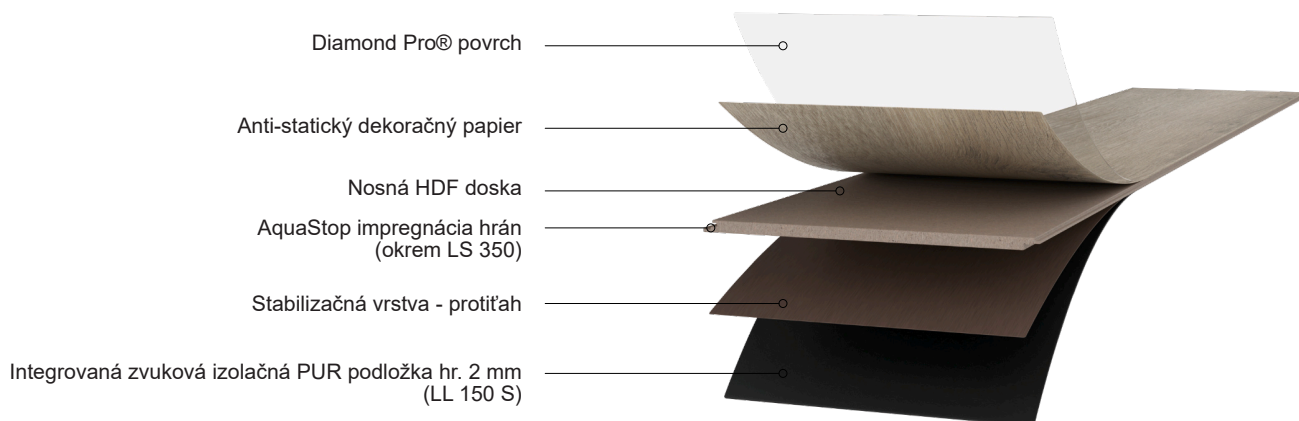

Detaily produktu:

- Krátke dosky (vzor „Rybia kost“)
- Trieda záťaže 23 I 32
- Micro-skosená hrana po celom obvode
- Vhodná do vlhkých miestností | vode-odolná 24 hodín
- AquaSafe+ nosná doska
- Povrch Diamond Pro
- Antistatický povrch
- Typ zámkového spoja: UniZip
- MEISTER záruka*
 - 25 rokov v obytných priestoroch
 - 5 rokov v komerčných priestoroch

Technické údaje:

Hrúbka celková (mm)	10,0
Rozmer lamely (mm)	840 x 168
Počet lamiel / bal.	11
Balenie (m ²)	1,552
Hmotnosť balenia (kg)	14,0
Paleta: bal. m ² kg	49 balíkov 76,05 m ² 710 kg
Teplný odpor (EN 12 664)	0,071 (m ² K)/W

MeisterDesign. laminate - LL 250 (5GDry)

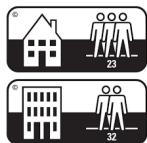

Kód produktu	Názov dekoru	Kompatibilná lišta	EUR /m ² bez DPH	EUR /m ² s DPH
600009-2052248-07124	White mountain oak 7124	06268		
600009-2052248-07130	Nutmeg castle oak 7130	07130		
600009-2052248-07143	Stream oak 7143	07143	31,76	38,12
600009-2052248-07144	Light valley oak 7144	07144		

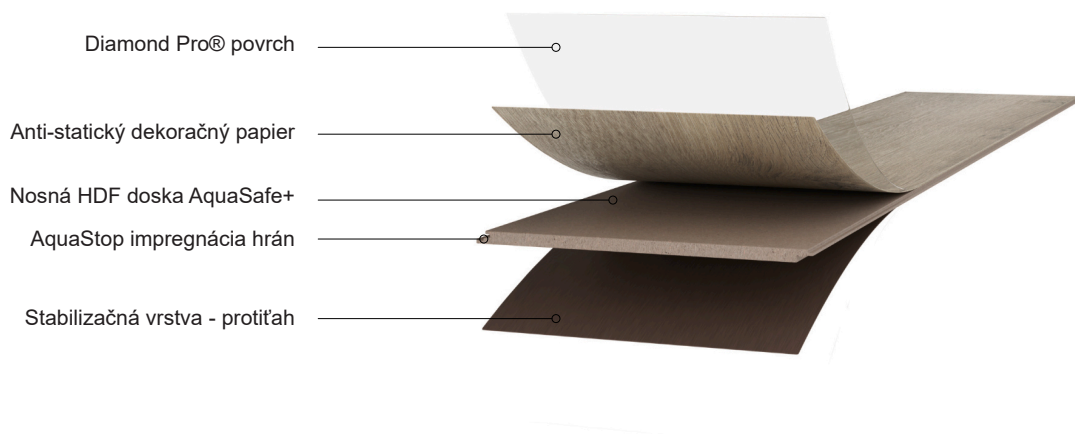

Detaily produktu:

- 1-lamela (palubový vzor)
- Trieda záťaž 23 I 32
- Micro-skosená hrana po celom obvode
- Komplexná ochrana proti vlhkosti: AquaSafe+ system
- Vhodná do vlhkých miestností | vode-odolná 24 hodín
- Povrch Diamond Pro
- Antistatický povrch
- Typ zámkového spoja: 5G™ Dry™
- MEISTER záruka*
 - 25 rokov v obytných priestoroch
 - 5 rokov v komerčných priestoroch

Technické údaje:

Hrúbka celková (mm)	10,0
Rozmer lamely (mm)	2052 x 248
Počet lamiel / bal.	4
Balenie (m ²)	2,036
Hmotnosť balenia (kg)	19,5
Paleta: bal. m ² kg	42 balíkov 85,51 m ² 840 kg
Teplný odpor (EN 12 664)	0,071 (m ² K)/W

MeisterDesign. laminate - LD 250

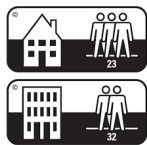

Kód produktu	Názov dekoru	Kompatibilná lišta	EUR /m ² bez DPH	EUR /m ² s DPH
600002-1288244-07122	Sand cliff oak 7122	07122	27,18	32,62
600002-1288244-06895	Sand princess oak 6895	07456		

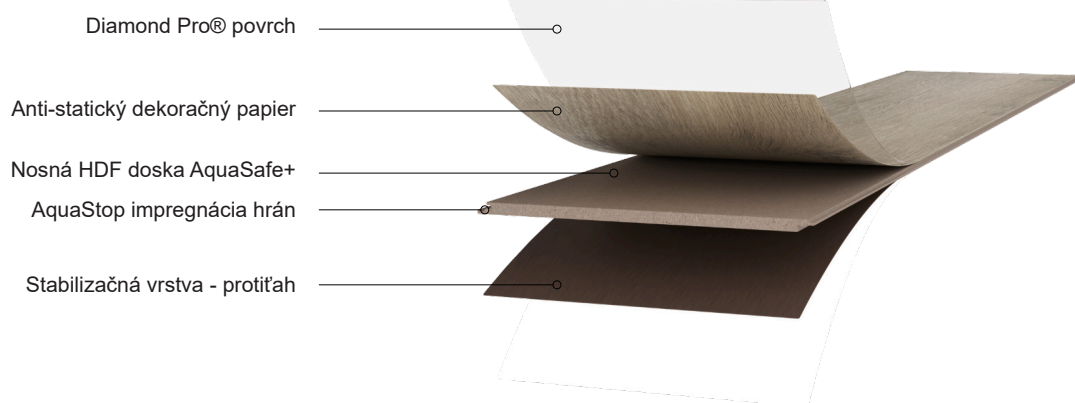

Detaily produktu:

- 1-lamela (široké krátke dosky)
- Trieda záťaž 23 I 32
- Micro-skosená hrana po celom obvode
- Komplexná ochrana proti vlhkosti: AquaSafe+ system
- Vhodná do vlhkých miestností I vode-odolná 24 hodín
- Povrch Diamond Pro
- Antistatický povrch
- Typ zámkového spoja: MultiClic
- MEISTER záruka*
 - 25 rokov v obytných priestoroch
 - 5 rokov v komerčných priestoroch

Technické údaje:

Hrúbka celková (mm)	10,0
Rozmer lamely (mm)	1288 x 244
Počet lamiel / bal.	6
Balenie (m ²)	1,886
Hmotnosť balenia (kg)	17,5
Paleta: bal. I m ² I kg	39 balíkov I 73,55 m ² I 710 kg
Teplný odpor (EN 12 664)	0,071 (m ² K)/W

MeisterDesign. laminate - LL 150 (5GDry)

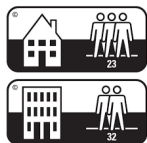

Kód produktu	Názov dekoru	Kompatibilná lišta	EUR /m ² bez DPH	EUR /m ² s DPH
600007-2052220-06256	Cognac rustic oak 6256	06256		
600007-2052220-06258	Light cracked oak 6258	06258		
600007-2052220-06389	Amore walnut 6389	06389		
600007-2052220-06413	Nova oak 6413	06413		
600007-2052220-06416	Muscat oak 6416	06416		
600007-2052220-07112	Monastery oak 7112	07112	25,16	30,20
600007-2052220-07114	Natural old wood oak 7114	06983		
600007-2052220-07116	Steamed riverbank oak 7116	06832		
600007-2052220-07117	Natural riverbank oak 7117	06064		
600007-2052220-07126	White riverbank oak 7126	06838		

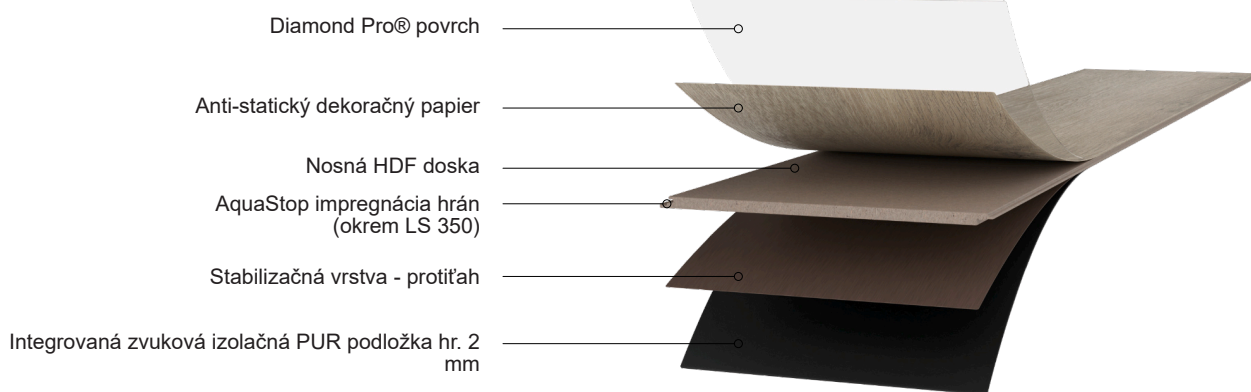

Detaily produktu:

- 1-lamela (palubový vzor)
- Trieda záťaže 23 I 32
- Skosená hrana po celom obvode
- Vhodná do vlhkých miestností | vode-odolná 4 hodiny
- Povrch Diamond Pro
- Antistatický povrch
- Typ zámkového spoja: 5G™ Dry™
- MEISTER záruka*
25 rokov v obytných priestoroch
5 rokov v komerčných priestoroch

Technické údaje:

Hrúbka celková (mm)	8,0
Rozmer lamely (mm)	2052 x 220
Počet lamiel / bal.	6
Balenie (m ²)	2,709
Hmotnosť balenia (kg)	20,5
Paleta: bal. m ² kg	36 balíkov 97,52 m ² 770 kg
Tepelný odpor (EN 12 664)	0,057 (m ² K)/W

MeisterDesign. laminate - LD 200 **NOVINKA**

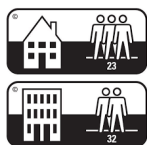

Kód produktu	Názov dekoru	Kompatibilná lišta	EUR /m ² bez DPH	EUR /m ² s DPH
600004-1288244-06899	Kingdom oak 6899	07395		
600004-1288244-07111	Dark Fountain oak 7111	06389	22,14	26,57
600004-1288244-07110	Fountain oak 7110	06067		

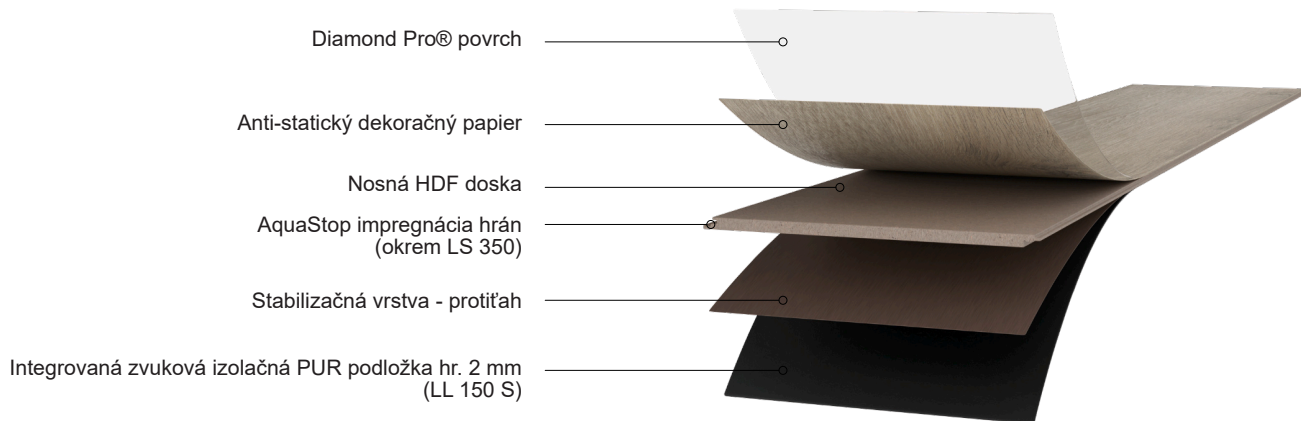

Detaily produktu:

- 1-lamela (široké krátke dosky)
- Trieda záťaže 23 | 32
- Micro-skosená hrana po celom obvode
- Vhodná do vlhkých miestností | vode-odolná 4 hodiny
- Povrch Diamond Pro
- Antistatický povrch
- Typ zámkového spoja: MultiClic
- MEISTER záruka*
25 rokov v obytných priestoroch
5 rokov v komerčných priestoroch

Technické údaje:

Hrúbka celková (mm)	8,0
Rozmer lamely (mm)	1288 x 244
Počet lamiel / bal.	8
Balenie (m ²)	2,514
Hmotnosť balenia (kg)	18,5
Paleta: bal. m ² kg	36 balíkov 90,51 m ² 690 kg
Tepelný odpor (EN 12 664)	0,057 (m ² K)/W

MeisterDesign. laminate - LD 150

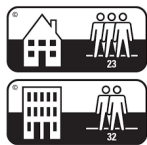

Kód produktu	Názov dekoru	Kompatibilná lišta	EUR /m ² bez DPH	EUR /m ² s DPH
600017-1288198-06376	Light Chiemsee oak 6376	06376		
600017-1288198-06421	Caledonia oak 6421	06421		
600017-1288198-06428	Taverna oak 6428	06428		
600017-1288198-06429	Habanera oak 6429	06429		
600017-1288198-06439	Cracked Terra oak 6439	06439		
600017-1288198-07004	Sand oak 7004	06259	18,85	22,62
600017-1288198-07014	Woodend oak 7014	06983		
600017-1288198-07113	Pure relax oak 7113	06428		
600017-1288198-07149	Chianti oak 7149	06392		
600017-1288198-07013	Hazelbrook oak 7013	07013		
600017-1288198-07005	Cream grey oak 7005	06288		

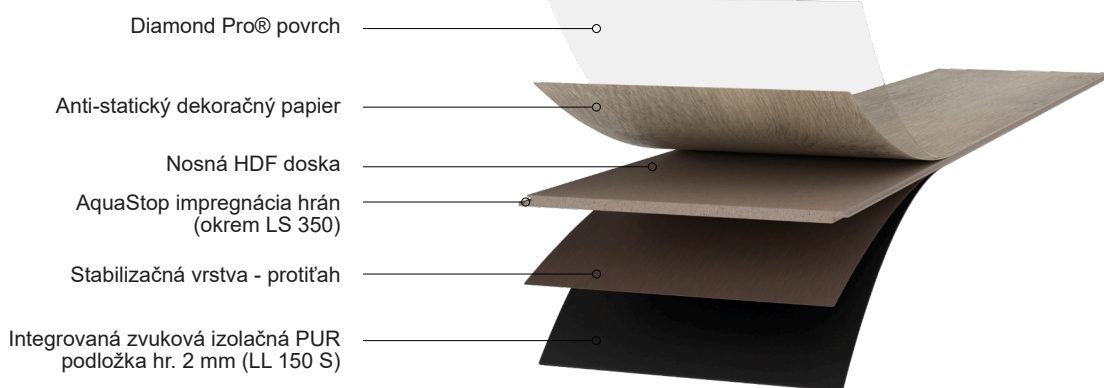

Detaily produktu:

- 1-lamelá (palubový vzor)
- Trieda záťaže 23 I 32
- Skosená hrana po celom obvode
- Vhodná do vlhkých miestností | vode-odolná 4 hodiny
- Povrch Diamond Pro
- Antistatický povrch
- Typ zámkového spoja: MultiClic
- MEISTER záruka*
 - 25 rokov v obytných priestoroch
 - 5 rokov v komerčných priestoroch

Technické údaje:

Hrúbka celková (mm)	8,0
Rozmer lamely (mm)	1288 x 198
Počet lamiel / bal.	10
Balenie (m ²)	2,550
Hmotnosť balenia (kg)	18,5
Paleta: bal. m ² kg	36 balíkov 91,80 m ² 700 kg
Tepelný odpor (EN 12 664)	0,057 (m ² K)/W

MeisterDesign. laminate - LC 150

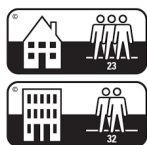

Kód produktu	Názov dekoru	Kompatibilná lišta	EUR /m ² bez DPH	EUR /m ² s DPH
600014-1288198-00462	Oak 462 3-strip	00462		
600014-1288198-06201	Beech 6201 3-strip	06201		
600014-1288198-06414	Casablanca oak 6414	06414		
600014-1288198-07119	Off-white tower oak 7119	06268	16,59	19,91
600014-1288198-07148	Monclair oak 7148	06442		
600014-1288198-07120	Cream tower oak 7120	06846		

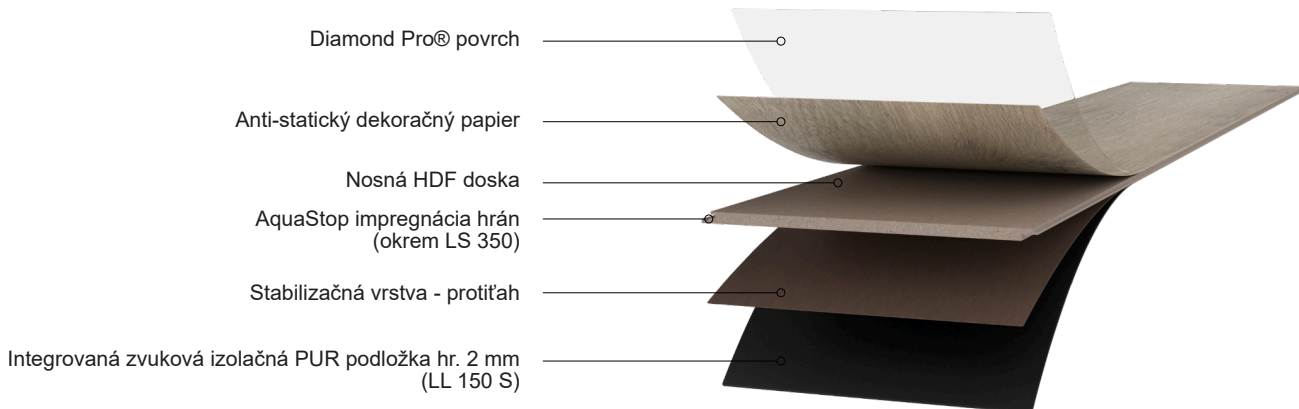

Detaily produktu:

- Krátke dosky 1-lamela (palubový vzor); 3-lamela (parketový vzor)
- Trieda záťaže 23 I 32
- Bez skosenej hrany
- Vhodná do vlhkých miestností I vode-odolná 4 hodiny
- Povrch Diamond Pro
- Antistatický povrch
- Typ zámkového spoja: MultiClic
- MEISTER záruka*
 - 25 rokov v obytných priestoroch
 - 5 rokov v komerčných priestoroch

Technické údaje:

Hrúbka celková (mm)	8,0
Rozmer lamely (mm)	1288 x 198
Počet lamiel / bal.	10
Balenie (m ²)	2,550
Hmotnosť balenia (kg)	18,5
Paleta: bal. I m ² I kg	36 balíkov I 91,80 m ² I 700 kg
Teplný odpor (EN 12 664)	0,057 (m ² K)/W

Pri objednávke vymeňte bodky na konci

čísla produktu s číslicami požadovaného čísla dekoru

(napr. Profil 3 PK, Maple 00202 = 200005-2380-00202)

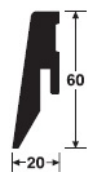

Profil
3 PK

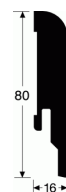

Profil
5 PK



Profil
8 PK

200005-2380-...

200006-2380-...

200015-2380-...

Názov dekoru	Číslo dekoru	200005-2380-...		200006-2380-...		200015-2380-...	
		EUR / bm bez DPH	EUR / bm s DPH	EUR / bm bez DPH	EUR / bm s DPH	EUR / bm bez DPH	EUR / bm s DPH
Maple	00202	4,14	4,97				
Walnut	00211	4,14	4,97				
Oak	00462	4,14	4,97	4,95	5,94		
Oak	06064	4,14	4,97	4,95	5,94		
Natural oak	06067	4,14	4,97				
Medium oak	06131	4,14	4,97	4,95	5,94		
Slate grey	06136					4,81	5,77
Slate anthracite	06137	4,14	4,97			4,81	5,77
White lyed oak	06181	4,14	4,97	4,95	5,94		
Boathouse oak	06188	4,14	4,97	4,95	5,94		
Beech	06201	4,14	4,97	4,95	5,94		
Cognac rustic oak	06256	4,14	4,97				
Light cracked oak	06258	4,14	4,97	4,95	5,94		
Light boathouse oak	06259	4,14	4,97	4,95	5,94		
Cappuccino oak	06263	4,14	4,97	4,95	5,94		
Marzipan oak	06268	4,14	4,97	4,95	5,94		
Distinctive pure oak	06273	4,14	4,97	4,95	5,94		
White grey oak	06277	4,14	4,97	4,95	5,94		
Mohair grey vintage oak	06288	4,14	4,97				
Light Chiemsee oak	06376	4,14	4,97				
Atacama oak	06380	4,14	4,97	4,95	5,94		
Dakar oak	06385	4,14	4,97				
Amore walnut	06389	4,14	4,97	4,95	5,94		
Chianti oak	06392	4,14	4,97	4,95	5,94		
Marrakech oak	06396	4,14	4,97	4,95	5,94		
Arcadia oak	06412	4,14	4,97	4,95	5,94		
Nova oak	06413	4,14	4,97	4,95	5,94		
Casablanca oak	06414	4,14	4,97	4,95	5,94		
Muscat oak	06416	4,14	4,97	4,95	5,94		
Caledonia oak	06421	4,14	4,97	4,95	5,94		
Taverna oak	06428	4,14	4,97	4,95	5,94		
Habanera oak	06429	4,14	4,97	4,95	5,94		
Cracked Terra oak	06439	4,14	4,97	4,95	5,94		
Walnut	06440	4,14	4,97				

Základný materiál (nosič)	MDF E1	MDF E1	MDF E1
Dĺžka v mm	2 380	2 380	2 380
Počet kusov v balení	4	4	4
Množstvo bm v balení	9,52	9,52	9,52
Uchytávací systém	800000-00001	800000-00001	800000-00001

Pri objednávke vymeňte bodky na konci

čísla produktu s číslicami požadovaného čísla dekoru

(napr. Profil 3 PK, Maple 00202 = 200005-2380-00202)

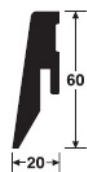

Profil
3 PK

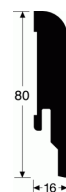

Profil
5 PK



Profil
8 PK

200005-2380-...

200006-2380-...

200015-2380-...

Názov dekoru	Číslo dekoru	200005-2380-...		200006-2380-...		200015-2380-...	
		EUR / bm bez DPH	EUR / bm s DPH	EUR / bm bez DPH	EUR / bm s DPH	EUR / bm bez DPH	EUR / bm s DPH
Grey oak	06442	4,14	4,97	4,95	5,94		
Oak	06443	4,14	4,97	4,95	5,94		
White oak	06670	4,14	4,97				
Grey oak	06671	4,14	4,97	4,95	5,94		
Cabana wood	06681	4,14	4,97				
Natural farmer's oak	06832	4,14	4,97	4,95	5,94		
Natural castle oak	06836	4,14	4,97	4,95	5,94		
Glacier oak	06838	4,14	4,97				
Light castle oak	06841	4,14	4,97				
Light field oak	06843	4,14	4,97	4,95	5,94		
Light fjord oak	06846	4,14	4,97				
Copper iron	06857					4,81	5,77
Madras oak	06891	4,14	4,97				
Natural English oak	06952	4,14	4,97				
Caramel oak	06953	4,14	4,97	4,95	5,94		
Natural English oak	06983	4,14	4,97	4,95	5,94		
Desert oak	06998	4,14	4,97				
Hazelbrook oak	07013	4,14	4,97				
Fairview oak	07015	4,14	4,97				
Monastery oak	07112	4,14	4,97				
Sand cliff oak	07122	4,14	4,97				
Honey riverbank oak	07127	4,14	4,97				
Nutmeg castle oak	07130	4,14	4,97				
Pure princess oak	07132	4,14	4,97				
Stream oak	07143	4,14	4,97				
Light valley oak	07144	4,14	4,97				
Springdale oak	07395	4,14	4,97				
Fleetwood oak	07399	4,14	4,97				
Black rock	07437					4,81	5,77
Mineral stone	07438					4,81	5,77
Cream stone	07439	4,14	4,97			4,81	5,77
Natural lakewood oak	07456	4,14	4,97				
Lakewood oak	07457	4,14	4,97				

Základný materiál (nosič)	MDF E1	MDF E1	MDF E1
Dĺžka v mm	2 380	2 380	2 380
Počet kusov v balení	4	4	4
Množstvo bm v balení	9,52	9,52	9,52
Uchytávací systém	800000-00001	800000-00001	800000-00001

Pri objednávke vymeňte bodky na konci čísla produktu s číslicami požadovaného čísla dekoru (napr. Profil 10 PK, Plain white gloss DF = 200000-2380-00324)

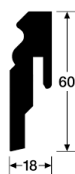

Profil
10 PK



Profil
11 PK



Profil
12 PK



Profil
13 PK

200000-2380-...

200001-2380-...

200002-2380-...

200003-2380-...

Název dekoru	Číslo dekoru	EUR / bm bez DPH	EUR / bm s DPH	EUR / bm bez DPH	EUR / bm s DPH	EUR / bm bez DPH	EUR / bm s DPH	EUR / bm bez DPH	EUR / bm s DPH
Plain white gloss DF	00324	4,07	4,88	4,53	5,44	4,99	5,99	5,46	6,55
White DF (paintable)	02222	4,07	4,88	4,53	5,44	4,99	5,99	5,46	6,55

Základný materiál (nosič)	MDF E1	MDF E1	MDF E1	MDF E1
Dĺžka v mm	2 380	2 380	2 380	2 380
Počet kusov v balení	4	4	4	4
Množstvo bm v balení	9,52	9,52	9,52	9,52
Uchytávací systém	800000-00001	800000-00001	800000-00001	800000-00001

Zodpovedajúce vnútorné rohy, vonkajšie rohy, spojovacie kusy a koncovky pozri stranu 14 - 17.



Profil
14 MK

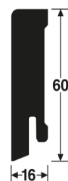

Profil
15 MK



Profil
16 MK



Profil
20 PK

200009-2380-...

200010-2380-...

200011-2380-...

200013-2380-...

Název dekoru	Číslo dekoru	EUR / bm bez DPH	EUR / bm s DPH	EUR / bm bez DPH	EUR / bm s DPH	EUR / bm bez DPH	EUR / bm s DPH	EUR / bm bez DPH	EUR / bm s DPH
Anthracite DF	00059	2,90	3,48	3,38	4,06	3,86	4,64	3,38	4,06
Stainless steel DF	00063	3,48	4,18	3,97	4,76	4,45	5,34	3,97	4,76
Plain white gloss DF	00324	2,77	3,33	3,23	3,88	3,70	4,44	3,23	3,88
White DF (paintable)	02222	2,77	3,33	3,23	3,88	3,70	4,44	3,23	3,88
Black DF	02277							3,38	4,06

Základný materiál (nosič)	MDF E1	MDF E1	MDF E1	MDF E1
Dĺžka v mm	2 380	2 380	2 380	2 380
Počet kusov v balení	4	4	4	4
Množstvo bm v balení	9,52	9,52	9,52	9,52
Uchytávací systém	800000-00003	800000-00003	800000-00003	800000-00001

Zodpovedajúce vnútorné rohy, vonkajšie rohy, spojovacie kusy a koncovky pozri stranu 14 - 17.

Pri objednávke vymeňte body na konci čísla produktu s číslicami požadovaného čísla dekoru (napr. Profil 2 PK, Stainless steel DF = 200004-2380-00063)



Profil
2 PK



Profil
3 PK

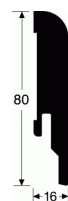

Profil
5 PK



Profil 6

Název dekoru	Číslo dekoru	200004-2380-...		200005-2380-...		200006-2380-...		200007-2380-...	
		EUR / bm bez DPH	EUR / bm s DPH	EUR / bm bez DPH	EUR / bm s DPH	EUR / bm bez DPH	EUR / bm s DPH	EUR / bm bez DPH	EUR / bm s DPH
Stainless steel DF	00063			4,26	5,11				
Plain white gloss DF	00324	3,42	4,11	3,51	4,21	4,26	5,11	1,94	2,32
White DF (paintable)	02222	3,42	4,11	3,51	4,21	4,26	5,11	1,94	2,32

Základný materiál (nosič)	MDF E1	MDF E1	MDF E1	MDF E1
Dĺžka v mm	2 380	2 380	2 380	2 380
Počet kusov v balení	4	4	4	20
Množstvo bm v balení	9,52	9,52	9,52	47,60
Uchytávací systém	800000-00001	800000-00001	800000-00001	

Zodpovedajúce vnútorné rohy, vonkajšie rohy, spojovacie kusy a koncovky pozri stranu 14 - 17.

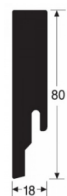

Profil
9 PK

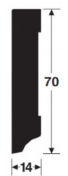

Profil 17



Profil
18 PK



Profil
19 PK

Název dekoru	Číslo dekoru	200016-2380-...		200012-2380-...		200017-2380-...		200018-2380-...	
		EUR / bm bez DPH	EUR / bm s DPH	EUR / bm bez DPH	EUR / bm s DPH	EUR / bm bez DPH	EUR / bm s DPH	EUR / bm bez DPH	EUR / bm s DPH
Anthracite DF	00059	5,12	6,14						
Stainless steel DF	00063	5,80	6,96						
Plain white gloss DF	00324	4,90	5,87	3,05	3,66	4,16	4,99	5,27	6,32
White DF (paintable)	02222	4,90	5,87	3,05	3,66				
Black DF	02277	5,12	6,14						

Základný materiál (nosič)	MDF E1	MDF E1	MDF E1	MDF E1
Dĺžka v mm	2 380	2 380	2 380	2 380
Počet kusov v balení	4	4	4	4
Množstvo bm v balení	9,52	9,52	9,52	9,52
Uchytávací systém	800000-00001		800000-00001	800000-00001

Zodpovedajúce vnútorné rohy, vonkajšie rohy, spojovacie kusy a koncovky pozri stranu 14 - 17.

Pri objednávke vymeňte body na konci čísla produktu s číslicami požadovaného čísla dekoru (napr. Profil 2 PK, Stainless steel DF = 200004-2380-00063)

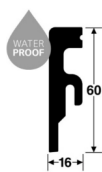

Profil
20 PK AQUA



Profil
8 PK



Profil 7

200014-2380-...

200015-2380-...

200008-2380-...

Názov dekoru	Číslo dekoru	EUR / bm bez DPH	EUR / bm s DPH	EUR / bm bez DPH	EUR / bm s DPH	EUR / bm bez DPH	EUR / bm s DPH
Anthracite DF	00059			3,97	4,76		
Stainless steel DF	00063	6,38	7,66	4,74	5,69		
Plain white gloss DF	00324	5,54	6,65	3,80	4,55	1,94	2,32
White DF (paintable)	02222			3,80	4,55		
Black DF	02277			3,97	4,76	1,94	2,32

Základný materiál (nosič)	Polystyren	MDF E1	MDF E1
Dĺžka v mm	2 380	2 380	2 380
Počet kusov v balení	4	4	4
Množstvo bm v balení	9,52	9,52	9,52
Uchytávací systém	800000-00001	800000-00001	

Zodpovedajúce vnútorné rohy, vonkajšie rohy, spojovacie kusy a koncovky pozri stranu 14 - 17.

Vnútorné rohy, vonkajšie rohy a koncovky

Zladené komponenty pre
profil lišty 2 PK

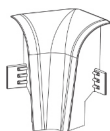

Vnútorný roh



Vonkajší roh



Ukončenie

800027-01-02001

800027-02-02001

800027-03-02001

Názov dekoru	Číslo dekoru	EUR / bal. bez DPH	EUR / bal. s DPH	EUR / bal. bez DPH	EUR / bal. s DPH	EUR / bal. bez DPH	EUR / bal. s DPH
White 02001	02001	7,30	8,76	5,27	6,32	5,27	6,32
Základný materiál (nosič)		ABS		ABS		ABS	
Počet kusov v balení		4		2		1 ľavé + 1 pravé	

Vnútorne rohy, vonkajšie rohy a koncovky

Zladené komponenty pre
profil lišty 3 PK

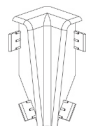

Vnútorný roh



Vonkajší roh



Ukončenie

Názov dekoru	Číslo dekoru	EUR / bal.	EUR / bal.	EUR / bal.	EUR / bal.	EUR / bal.	EUR / bal.
		bez DPH	s DPH	bez DPH	s DPH	bez DPH	s DPH
		7,30	8,76	5,27	6,32	5,27	6,32
White 02001	02001	800015-01-02001		800015-02-02001		800015-03-02001	
Stainless steel look 02002	02002	800015-01-02002		800015-02-02002		800015-03-02002	
Maple 02009	02009	800015-01-02009		800015-02-02009		800015-03-02009	
Beech 02011	02011	800015-01-02011		800015-02-02011		800015-03-02011	
Natural oak 02013	02013	800015-01-02013		800015-02-02013		800015-03-02013	
White oak 02014	02014	800015-01-02014		800015-02-02014		800015-03-02014	
Light walnut 02017	02017	800015-01-02017		800015-02-02017		800015-03-02017	
Light oak 02034	02034	800015-01-02034		800015-02-02034		800015-03-02034	
Základný materiál (nosič)		ABS		ABS		ABS	
Počet kusov v balení		4		2		1 ľavé + 1 pravé	

Aké príslušenstvo soklovej lišty použiť

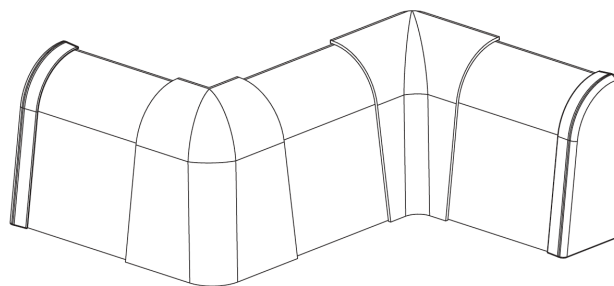
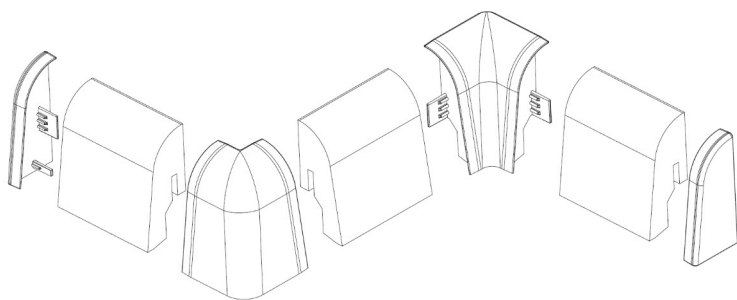

Maple 02009	Maple 00202
Beech 02011	Beech 06201
Light oak 02034	Light cracked oak 06258 / Distinctive pure oak 06273 / Light Chiemsee oak 06376 / Taverna oak 06428 / Light field oak 06843 / Madras oak 06891 / Pure princess oak 07132 / Natural lakewood oak 07456 / Lakewood oak 07457
Natural oak 02013	Oak 06064 / Natural castle oak 06836 / Hazelbrook oak 07013 / Fleetwood oak 07399
White oak 02014	White lyed oak 06181 / Marzipan oak 06268
Light walnut 02017	Walnut 00211 / Amore walnut 06389 / Walnut 06440

Vnútorne rohy, vonkajšie rohy a koncovky

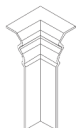

Vnútorný roh
(samolepiaci)

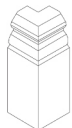

Vonkajší roh
(samolepiaci)

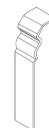

Spojka
(samolepiaca)

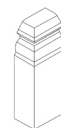

Ukončenie
(samolepiace)

Zodpovedajúce profilom: 10 PK I 10 F MK (60 mm)	EUR / bal.	EUR / bal.	EUR / bal.	EUR / bal.	EUR / bal.	EUR / bal.	EUR / bal.	EUR / bal.	EUR / bal.
	bez DPH	s DPH	bez DPH	s DPH	bez DPH	s DPH	bez DPH	s DPH	s DPH
	7,30	8,76	5,27	6,32	5,27	6,32	5,27	6,32	5,27
White 02001	800028-01-02001		800028-02-02001		800028-04-02001		800028-03-02001		

Zodpovedajúce profilom: 11 MK I 1 F MK (80 mm)	EUR / bal.	EUR / bal.	EUR / bal.	EUR / bal.	EUR / bal.	EUR / bal.	EUR / bal.	EUR / bal.	EUR / bal.
	bez DPH	s DPH	bez DPH	s DPH	bez DPH	s DPH	bez DPH	s DPH	s DPH
	7,30	8,76	5,27	6,32	5,27	6,32	5,27	6,32	5,27
White 02001	800029-01-02001		800029-02-02001		800029-04-02001		800029-03-02001		

Zodpovedajúce profilom: 12 PK I 12 F MK (100 mm)	EUR / bal.	EUR / bal.	EUR / bal.	EUR / bal.	EUR / bal.	EUR / bal.	EUR / bal.	EUR / bal.	EUR / bal.
	bez DPH	s DPH	bez DPH	s DPH	bez DPH	s DPH	bez DPH	s DPH	s DPH
	8,23	9,87	5,92	7,10	5,92	7,10	5,92	7,10	5,92
White 02001	800030-01-02001		800030-02-02001		800030-04-02001		800030-03-02001		

Zodpovedajúce profilom: 13 PK (120 mm)	EUR / bal.	EUR / bal.	EUR / bal.	EUR / bal.	EUR / bal.	EUR / bal.	EUR / bal.	EUR / bal.	EUR / bal.
	bez DPH	s DPH	bez DPH	s DPH	bez DPH	s DPH	bez DPH	s DPH	s DPH
	8,23	9,87	5,92	7,10	5,92	7,10	5,92	7,10	5,92
White 02001	800031-01-02001		800031-02-02001		800031-04-02001		800031-03-02001		

Základný materiál (nosič)	ASA	ASA	ASA	ASA
Počet kusov v balení	4	2	2	1 ľavé + 1 pravé

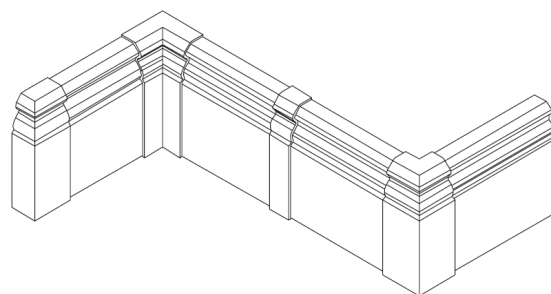
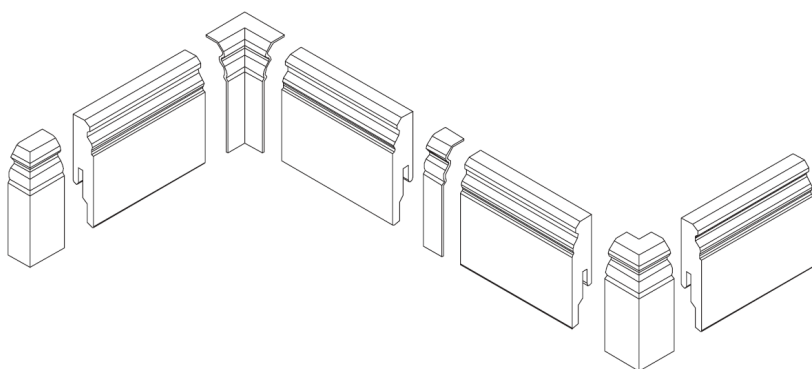

Vnútorné rohy, vonkajšie rohy a koncovky

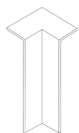

Vnútorný roh
(samolepiaci)



Vonkajší roh
(samolepiaci)



Spojka
(samolepiaca)



Ukončenie
(samolepiace)

Zodpovedajúce profilom: 8 PK I 18 PK (50 mm)	EUR / bal.	EUR / bal.	EUR / bal.	EUR / bal.	EUR / bal.	EUR / bal.	EUR / bal.	EUR / bal.	EUR / bal.
	bez DPH	s DPH	bez DPH	s DPH	bez DPH	s DPH	bez DPH	s DPH	bez DPH
	7,30	8,76	5,27	6,32	5,27	6,32	5,27	6,32	5,27
White 02001	800032-01-02001		800032-02-02001		800032-04-02001		800032-03-02001		

Zodpovedajúce profilom: 9 PK I 19 PK (80 mm)	EUR / bal.	EUR / bal.	EUR / bal.	EUR / bal.	EUR / bal.	EUR / bal.	EUR / bal.	EUR / bal.	EUR / bal.
	bez DPH	s DPH	bez DPH	s DPH	bez DPH	s DPH	bez DPH	s DPH	bez DPH
	7,30	8,76	5,27	6,32	5,27	6,32	5,27	6,32	5,27
White 02001	800033-01-02001		800033-02-02001		800033-04-02001		800033-03-02001		

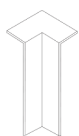

Vnútorný roh
(samolepiaci)



Vonkajší roh
(samolepiaci)



Spojka
(samolepiaca)



Ukončenie
(samolepiace)

Zodpovedajúce profilom: 15 MK I 15 F MK 20 PK I 20 PK Aqua	EUR / bal.	EUR / bal.	EUR / bal.	EUR / bal.	EUR / bal.	EUR / bal.	EUR / bal.	EUR / bal.	EUR / bal.
	bez DPH	s DPH	bez DPH	s DPH	bez DPH	s DPH	bez DPH	s DPH	bez DPH
	7,30	8,76	5,27	6,32	5,27	6,32	5,27	6,32	5,27
White 02001	800034-01-02001		800034-02-02001		800034-04-02001		800034-03-02001		
Stainless steel look 02038	800034-01-02038		800034-02-02038		800034-04-02038		800034-03-02038		
Black 02039	800034-01-02039		800034-02-02039		800034-04-02039		800034-03-02039		

Základný materiál (nosič)	ASA	ASA	ASA	ASA
Počet kusov v balení	4	2	2	1 ľavé + 1 pravé

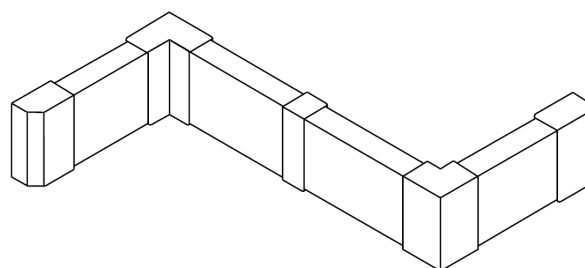
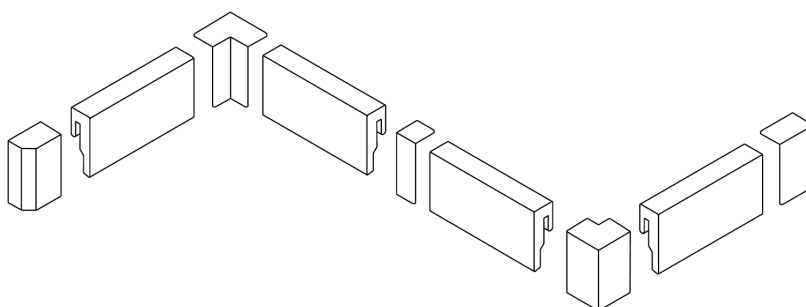

Originálne podložky pod podlahy

Kód produktu	Názov produktu	Rozmer (mm)	Balenie (m ²)	EUR / m ² bez DPH	EUR / m ² s DPH
800014-00004	MEISTER-Silence 25 dB	3,0 x 1000 x 5500	5,5	8,79	10,55

PUR, integrovaná parozábrana + Alu strip; útlm kročajového hluku 19 dB; priestor -31%; tlaková stabilita cca. 130kPa

800014-00005	MEISTER-Silence 20	2,5 x 1000 x 7000	7,0	6,00	7,20
--------------	--------------------	-------------------	-----	------	-------------

PUR-minerálna zmes; útlm kročajového hluku 19 dB; útlm priestorovej hlučnosti -28%; tlaková stabilita cca. 150kPa

800014-00006	MEISTER-Silence 15	2,0 x 1000 x 8500	8,5	5,73	6,88
--------------	--------------------	-------------------	-----	------	-------------

PUR, integrovaná parozábrana + Alu strip; útlm kročajového hluku 18 dB; priestor -25%; tlaková stabilita cca. 220kPa

800014-00008	MEISTER-Silence Compact	1,5 x 1000 x 10000	10,0	7,04	8,45
--------------	-------------------------	--------------------	------	------	-------------

Hrúbka 1,5 mm, vyrobená z PUR minerálnej zmesi určená k inštalácii plávajúcich dizajnových, rigidných a celovinylových podláh s klik systémom. Pevnosť v tlaku (hodnota CS): cca. 450 kPa Zníženie kročajového hluku: až 18 dB

800014-00010	MEISTER-SilenceEco VPE	3,0 x 590 x 790	9,322	2,63	3,15
--------------	------------------------	-----------------	-------	------	-------------

Tlakovo stabilná podložka z drevovlákná; útlm kročajového hluku 18 dB; tlaková stabilita cca. 150kPa

800014-00012	MEISTER-Twin Control foam	2,0 x 1000 x 25000	25,0	4,16	4,99
--------------	---------------------------	--------------------	------	------	-------------

Penová podložka s integrovanou parozábranou; útlm kročajového hluku 19 dB; priestor -15%; tlaková stabilita cca. 60kPa

800014-00001	MEISTER-Alu-Strip	0,2 x 50 x 50000	50,0	8,29	9,95
--------------	-------------------	------------------	------	------	-------------

Alumíniová lepiaca páska na zlepenie pásov podložky Meister-Twin Control

Kód produktu	Názov produktu	Materiál	EUR bez DPH	EUR s DPH
800001-00003	Meister tension rod - uťahovák posledného radu	ocel'	23,94	28,72
800001-00013	Tapping block 5 mm (inštalačný blok)	plast	9,26	11,11
800001-00010	Tapping block In&Out 7 mm (inštalačný blok)	plast	7,30	8,76
800001-00007	Drevené dištančné klíny	drevo	4,90	5,87
800001-00008	Upevňovací klin (ocel' + drevo)	ocel'/drevo	12,85	15,42

Uchytávacie klipy

Kód produktu	Obrázok	Názov produktu	Balenie (ks / bal.)	Spotreba (ks / bm)	MOC /bal. bez DPH	MOC /bal. s DPH
--------------	---------	----------------	---------------------	--------------------	-------------------	-----------------

800000-00001

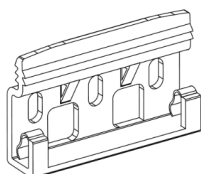

Uchytávacie klipy pre soklové lišty
2 PK, 3 PK, 5 PK, 8 PK,
9 PK, 10 PK, 11 PK, 12 PK, 13 PK,
18 PK, 19 PK, 20 PK a 20 PK Aqua

50 / bal.

50 klipov na 20 bm lišty

11,92

14,31

800000-00003



Uchytávacie klipy pre soklové lišty
10 F MK, 11 F MK, 12 F MK, 14 MK,
14 F MK, 15 MK, 15 F MK, 16 MK,
21 F MK, 22 F MK,
23 F MK

50 / bal.

50 klipov na 20 bm lišty

14,70

17,64

Radiatorové rozery z masívneho dreva

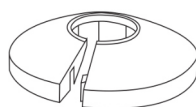

Ø 15 mm

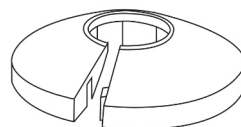

Ø 18 mm

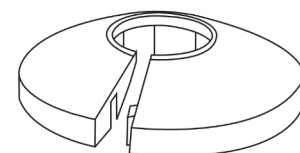

Ø 22 mm

Vnútorňý priemer

Vonkajší priemer

Ø 50 mm

Ø 50 mm

Ø 55 mm

Názov dekoru	Číslo dekoru	MOC /bal. bez DPH	MOC /bal. s DPH	MOC /bal. bez DPH	MOC /bal. s DPH	MOC /bal. bez DPH	MOC /bal. s DPH
		6,01	7,21	6,01	7,21	6,01	7,21
Oak 00001	00001	800002-15-00001		800002-18-00001		800002-22-00001	
Beech 00019	00019	800002-15-00019		800002-18-00019		800002-22-00019	
		6,66	7,99	6,66	7,99	6,66	7,99
Walnut 00015	00015	800002-15-00015		800002-18-00015		800002-22-00015	

Radiatorové rozery plastové

Kód produktu	Názov produktu	Balenie	EUR bez DPH	EUR s DPH
800002-00-02009	Maple 02009 (wood effect)	2 ks	7,30	8,76
800002-00-02011	Beech 02011 (wood effect)	2 ks	7,30	8,76
800002-00-02013	Natural oak 02013 (wood effect)	2 ks	7,30	8,76
800002-00-02014	White oak 02014 (wood effect)	2 ks	7,30	8,76
800002-00-02017	Walnut 02017 (wood effect)	2 ks	7,30	8,76
800002-00-02034	Light oak 02034 (wood effect)	2 ks	7,30	8,76
800002-00-02035	Chrome 02035 (decor)	2 ks	7,30	8,76
800002-00-02043	White 02043 (decor)	2 ks	7,30	8,76

Vnútorňý priemer	Ø 15 18 22 mm
Vonkajší priemer	Ø 50 mm
Materiál	ABS

Zladené radiatorové rozery s laminátovými a diajnovými podlahami MEISTER

Mapple 02009	Maple 02009
Beech 02011	Beech 06201
Light oak 02034	Light cracked oak 06258 / Marrakech oak 06396 / Casablanca oak 06414 / Taverna oak 06428 / Bayfield oak 06679 / Light castle oak 06841 / Sand princess oak 06895 / Kingdom oak 06899 / Caramel oak 06953 / Champagne oak 07001 / Pure relax oak 07113 / Cream tower oak 07120 / Toffee oak 07142 / Light valley oak 07144 / Pure fountain oak 07152
Natural oak 02013	Oak 00462 / Natural oak 06067 / Oak 06443 / East coast oak 06682 / Natural farmer's oak 06832 / Hazelbrook oak 07013 / Woodend oak 07014 / Villa oak 07016 / Steamed riverbank oak 07116 / Natural riverbank oak 07117 / Nevado oak 07147 / Chianti oak 07149 / Hill oak 07153
White oak 02014	White lyed oak 06181 / Marzipan oak 06268 / Atacama oak 06380 / Off-white tower oak 07119 / Sand cliff oak 07122 / White mountain oak 07124 / White riverbank oak 07126
Walnut 02017	Walnut 00211 / Amore walnut 06389 / Walnut 06440 / Muscat oak 06416 / Dark fountain oak 07111

Údržba - čistenie

Kód produktu	Názov produktu	Balenie	EUR bez DPH	EUR s DPH
800021-00001-A17	Dr.Schutz Laminate Reiniger 750ml (DE ver.)	1 ks	9,06	10,88
800021-00002-A22	Dr.Schutz Laminate Cleaner 750ml (EN ver.)	1 ks	9,06	10,88

Vhodné na bežné čistenie všetkých laminátových podláh MEISTER a Nadura. Odstraňuje nečistoty, masťotu a šmuhy od podrážok topánok. Čistí jemne, ale dôkladne. Obsah: 750 ml. Balenie: plastová fľaša - koncentrát).

Kód produktu	Názov produktu	Balenie	EUR bez DPH	EUR s DPH
800021-00019-A17	Dr.Schutz Elatex universal 200ml (DE ver.)	1 ks	10,08	12,09
800021-00019-A17	Dr.Schutz Elatex universal 200ml (EN ver.)	1 ks	10,08	12,09

Dr. Schutz-Elatex univerzálny odstraňovač škvŕn - odstraňuje šmuhy od podrážok topánok a odolné nečistoty. Balenie: plastová fľaša s rozprašovačom. Pripravené k aplikácii.