

**MEISTER**

# Cenník

MeisterDesign. vinyl

2024

## PREHĽAD KOLEKCIÍ

Kolekcia	Spoj	Vode- odolnosť	Záťaž	V - drážka	Balenie (m <sup>2</sup> )	Rozmer (mm)	MOC bez DPH/m <sup>2</sup>	MOC s DPH/m <sup>2</sup>
Comfort DL 600 S	MasterClic Plus	4 h	33	micro po celom obvode	2,696	9 x 219 x 2.052	48,49	58,19
Comfort DD 600 S	MasterClic Plus	4 h	33	micro po celom obvode	1,982	9 x 220 x 1.287	44,96	53,95
Comfort DB 600 S	MasterClic Plus	4 h	33	micro po celom obvode	2,359	9 x 395 x 853	48,49	58,19
Next DL 500 S	MasterClic Plus	24 h	33	micro po celom obvode	2,709	8 x 220 x 2.052	39,66	47,59
Next DD 500 S	MasterClic Plus	24 h	33	micro po celom obvode	2,265	8 x 220 x 1.287	36,13	43,36
Next DB 500 S	MasterClic Plus	24 h	33	micro po celom obvode	2,695	8 x 395 x 853	39,66	47,59
Flex DL 400	Multiclic	4 h	33	micro po celom obvode	3,107	5 x 216 x 2.055	35,25	42,30
Flex DD 400	Multiclic	4 h	33	micro po celom obvode	3,344	5 x 216 x 1.290	31,72	38,06
Flex DB 400	Multiclic	4 h	33	micro po celom obvode	3,423	5 x 399 x 858	36,93	44,31
Allround DD 700 S	Multiclic	áno	33	micro po celom obvode	2,203	5,5 x 244 x 1.290	49,37	59,25
Pro DD 200	celoplošné lepenie	áno	33	micro po celom obvode	4,254	2 x 219 x 1.295	42,30	50,77
Rigid RL 400 S	Multiclic	áno	33	micro po celom obvode	1,803	6 x 197 x 1.830	42,30	50,77
Rigid RB 400 S	Multiclic	áno	33	micro po celom obvode	2,027	6 x 397 x 851	42,30	50,77
Rigid RD 300 S	Multiclic	áno	33	micro po celom obvode	2,059	5,5 x 228 x 1.290	39,66	47,59

Kompletnú ponuku dizajnových podláh MEISTER so všetkými kolekciami a dekormi vrátane príslušenstva nájdete na našich webových stránkach [www.bausad.sk](http://www.bausad.sk).

Poznámka:

Predaj možný iba na ucelené balenia!

## MeisterDesign. comfort - DD 500 S

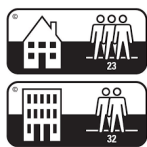

Kód produktu	Názov dekoru	Kompatibilná lišta	MOC bez DPH/m <sup>2</sup>	MOC s DPH/m <sup>2</sup>
400004-1287220-06843	Light field oak 6843	06843		
400004-1287220-06844	Natural field oak 6844	06844		
400004-1287220-06977	Grey wild oak 6977	06977		
400004-1287220-06983	Natural English oak 6983	06983		
400004-1287220-06985	Pure English oak 6985	06985	36,13	43,36
400004-1287220-06986	Clay grey old wood oak 6986	06986		
400004-1287220-06990	Lakeside oak 6990	06990		
400004-1287220-06998	Desert oak 6998	06998		
400004-1287220-06999	Golden oak 6999	06999		

Puretec® Plus povrch - Priehľadná polymérová vrstva na báze PUR (bez PVC)

Dekoračná vrstva

Základová vrstva pod dekoračný papier

Špeciálna doska AquaSafe (redukujúca napučanie) – na báze prírodných, obnoviteľných materiálov

1mm integrovaná korková podložka pohlcujúca zvuk

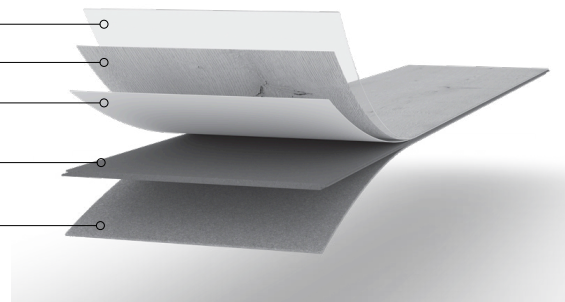

### Detaily produktu:

- 1-lamelový vzor
- Trieda záťaže 23 I 33
- Micro-skosená hrana po celom obvode
- Vhodná do vlhkých miestností | vode-odolná 4 hodiny
- Špeciálna AquaSafe+ nosná doska
- Povrch Puretec® Plus ; Antistatický povrch
- 1mm integrovaná korková podložka pohlcujúca zvuk
- Typ zámkového spoja: Masterclit Plus
- MEISTER záruka\*
  - 25 rokov v obytných priestoroch
  - 5 rokov v komerčných priestoroch

### Technické údaje:

Hrúbka celková (mm)	8,0
Rozmer lamely (mm)	1287 x 220
Počet lamiel / bal.	8
Balenie (m <sup>2</sup> )	2,265
Hmotnosť balenia (kg)	16
Paleta: bal.   m <sup>2</sup>   kg	36 balíkov   81,54 m <sup>2</sup>   600 kg
Teplný odpor (EN 12 664)	0,068 (m <sup>2</sup> K)/W

## MeisterDesign. flex - DD 400

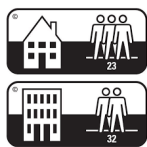

Kód produktu	Názov dekoru	Kompatibilná lišta	MOC bez DPH/m <sup>2</sup>	MOC s DPH/m <sup>2</sup>
400007-1290216-06843	Light field oak 6843	06843		
400007-1290216-06844	Natural field oak 6844	06844		
400007-1290216-06977	Grey wild oak 6977	06977		
400007-1290216-06983	Natural English oak 6983	06983		
400007-1290216-06985	Pure English oak 6985	06985		
400007-1290216-06986	Clay grey old wood oak 6986	06986	31,72	38,06
400007-1290216-06990	Lakeside oak 6990	06990		
400007-1290216-06998	Desert oak 6998	06998		
400007-1290216-06999	Golden oak 6999	06999		
400007-1290216-07118	Hill oak 07118	07399		

Puretec® Plus povrch - priehľadná polymérová vrstva na báze PUR (bez PVC)

Dekoračná vrstva

Základová vrstva pod dekoračný papier

Špeciálna doska AquaSafe (redukujúca napučanie) – na báze prírodných, obnoviteľných materiálov

AquaStop impregnácia hrán

Podklad pre optimálnu rozmerovú stabilitu

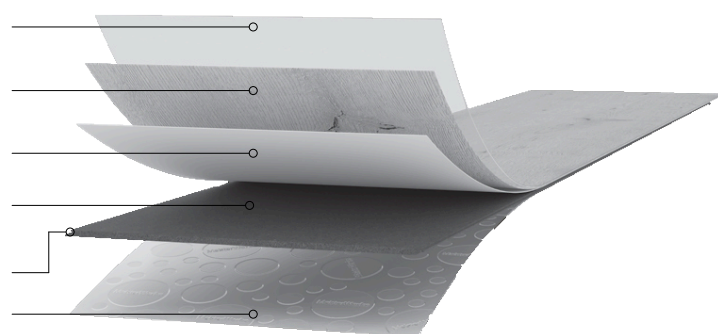

### Detaily produktu:

- 1-lamelový vzor
- Trieda záťaž 23 I 33
- Micro-skosená hrana po celom obvode
- Vhodná do vlhkých miestností | vode-odolná 4 hodiny
- Špeciálna AquaSafe+ nosná doska
- Povrch Puretec® Plus ; Antistatický povrch
- 1mm integrovaná korková podložka pohlcujúca zvuk
- Typ zámkového spoja: Multiclic
- MEISTER záruka\*
  - 25 rokov v obytných priestoroch
  - 5 rokov v komerčných priestoroch

### Technické údaje:

Hrúbka celková (mm)	5,0
Rozmer lamely (mm)	1290 x 216
Počet lamiel / bal.	12
Balenie (m <sup>2</sup> )	3,344
Hmotnosť balenia (kg)	16,0
Paleta: bal.   m <sup>2</sup>   kg	36 balíkov   120,38 m <sup>2</sup>   610 kg
Teplný odpor (EN 12 664)	0,035 (m <sup>2</sup> K)/W

## MeisterDesign. pro - DD 200

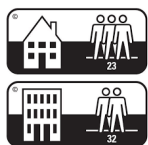

Kód produktu	Názov dekoru	Kompatibilná lišta	MOC bez DPH/m <sup>2</sup>	MOC s DPH/m <sup>2</sup>
400010-1295219-06843	Light field oak 6843	06843		
400007-1290216-06844	Natural field oak 6844	06844		
400007-1290216-06977	Grey wild oak 6977	06977		
400007-1290216-06983	Natural English oak 6983	06983		
400007-1290216-06985	Pure English oak 6985	06985	42,30	50,77
400007-1290216-06986	Clay grey old wood oak 6986	06986		
400007-1290216-06990	Lakeside oak 6990	06990		
400007-1290216-06998	Desert oak 6998	06998		
400007-1290216-06999	Golden oak 6999	06999		

Viacvrstvý povrch Puretec® s polyuretánovou krycou vrstvou (bez PVC)

ecuran základná doska - vodeodolná, poloelastická a bez PVC

Fleecová podložka pre optimálne prilepenie



### Detaily produktu:

- 1-lam. extra tenká profesionálna podlaha pre celoplošné lepenie
- Trieda záťaže 23 I 33
- Micro-skosená hrana po celom obvode
- Vhodná do vlhkých miestností (napr. kúpeľne) I vode-odolná
- Špeciálna Ecuran nosná doska, ťažko horľavá (Cfl-s1 DIN EN 13501)
- Viacvrstvý povrch Puretec® s polyuretánovou krycou vrstvou
- Vhodné pre teplovodné podlahové kúrenie
- Vodotesná, nenáročná na údržbu a odolná
- MEISTER záruka\*  
25 rokov v obytných priestoroch

### Technické údaje:

Hrúbka celková (mm)	2,0
Rozmer lamely (mm)	1295 x 219
Počet lamiel / bal.	15
Balenie (m <sup>2</sup> )	4,254
Hmotnosť balenia (kg)	14,0
Paleta: bal. I m <sup>2</sup> I kg	48 balíkov I 204,19 m <sup>2</sup> I 720 kg
Tepelný odpor (EN 12 664)	0,010 (m <sup>2</sup> K)/W

## MeisterDesign. pro - RL 400 S (rigid)

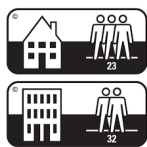

Kód produktu	Názov dekoru	Kompatibilná lišta	MOC bez DPH/m <sup>2</sup>	MOC s DPH/m <sup>2</sup>
400011-1830197-07403	Campside oak 7403	06983		
400011-1830197-07404	Baywood oak 7404	07404		
400011-1830197-07430	Golden creek oak 7430	07430		
400011-1830197-07431	Natural spring oak 7431	07431	42,30	50,77
400011-1830197-07432	Cracked Terra oak 7432	07404		
400011-1830197-07433	Dark cracked Terra oak 7433	07433		
400011-1830197-07434	Cold breeze 7434	07434		

Viacvrstvový vinylový povrch s PUR vrstvou (nášlapná vrstva 0,55 mm)

Dekoračná vrstva

Pevná vodotesná polymérová základná doska

Integrovaná zvuk pohlcujúca podložka z 1 mm XPS peny



### Detaily produktu:

- 1-lamelový vzor
- Trieda záťaže 23 | 33
- Micro-skosená hrana po celom obvode
- Vhodná do vlhkých miestností | vode-odolná
- Pevná vodotesná polymérová základná doska
- Viacvrstvový vinylový povrch s PUR náterom
- S integrovanou tlmiacou podložkou z 1 mm hrubej XPS peny
- Nenáročná na údržbu, odolná, vhodná pre vodné podlahové kúrenie
- MEISTER záruka\*
  - 25 rokov v obytných priestoroch
  - 5 rokov v komerčných priestoroch

### Technické údaje:

Hrúbka celková (mm)	6,0
Rozmer lamely (mm)	1830 x 197
Počet lamiel / bal.	5
Balenie (m <sup>2</sup> )	1,803
Hmotnosť balenia (kg)	17,5
Paleta: bal.   m <sup>2</sup>   kg	44 balíkov   79,33 m <sup>2</sup>   790 kg
Teplný odpor (EN 12 664)	0,050 (m <sup>2</sup> K)/W

## MeisterDesign. pro - RD 300 S (rigid)

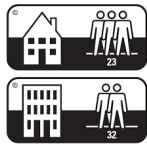

Kód produktu	Názov dekoru	Kompatibilná lišta	MOC bez DPH/m <sup>2</sup>	MOC s DPH/m <sup>2</sup>
400012-1290228-07328	Indian summer oak 7328   1-strip	06999		
400012-1290228-07330	Grey forest wood 7330 1-strip	06986		
400012-1290228-07386	Dark woodland 7386	06842		
400012-1290228-07387	Lakeshore oak 7387	07404		
400012-1290228-07388	Seafront oak 7388	06841		
400012-1290228-07389	High estate oak 7389	07389		
400012-1290228-07391	Timber wood 7391	07391	39,66	47,59
400012-1290228-07394	Arctica oak 7394	07394		
400012-1290228-07395	Springdale oak 7395	07395		
400012-1290228-07396	Westwood oak 7396	07404		
400012-1290228-07397	Hampstead oak 7397	07397		
400012-1290228-07390	Deep Grove oak 7390	07390		
400012-1290228-07399	Fleetwood oak 7399	07399		

Viacvrstvový vinylový povrch s PUR vrstvou (nášľapná vrstva 0,55 mm)

Dekoračná vrstva

Elastická tlmivacia vrstva

Integrovaná zvuk pohlcujúca podložka z 1 mm XPS peny

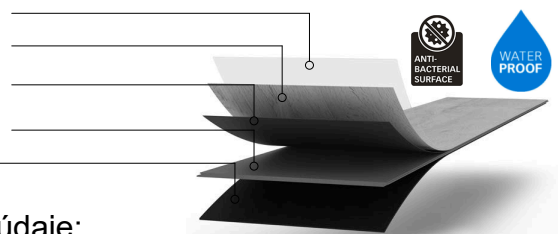

### Detaily produktu:

- 1-lamelový vzor (krátky dosky)
- Trieda záťaž 23 I 33
- Micro-skosená hrana po celom obvode
- Vhodná do vlhkých miestností | vode-odolná
- Pevná vodotesná polymérová základná doska
- Viacvrstvový vinylový povrch s PUR náterom
- S integrovanou tlmivou podložkou z 1 mm hrubej XPS peny
- Nenáročná na údržbu, odolná, vhodná pre vodné podlahové kúrenie
- MEISTER záruka\*
  - 25 rokov v obytných priestoroch
  - 5 rokov v komerčných priestoroch

### Technické údaje:

Hrúbka celková (mm)	5,5
Rozmer lamely (mm)	1290 x 228
Počet lamiel / bal.	7
Balenie (m <sup>2</sup> )	2,059
Hmotnosť balenia (kg)	13,5
Paleta: bal.   m <sup>2</sup>   kg	48 balíkov   98,83 m <sup>2</sup>   690 kg
Tepelný odpor (EN 12 664)	0,064 (m <sup>2</sup> K)/W

Pri objednávke vymeňte bodky na konci

čísla produktu s číslicami požadovaného čísla dekoru

(napr. profil 20 PK, Nova oak 06413 = 200013-2380-06413)

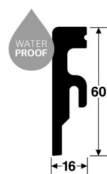

Profil  
20 PK Aqua

200014-2380-...



Profil  
20 PK

200013-2380-...



Profil  
8 PK

200015-2380-...

Názov dekoru	Číslo dekoru	200014-2380-...		200013-2380-...		200015-2380-...	
		EUR / bm bez DPH	EUR / bm s DPH	EUR / bm bez DPH	EUR / bm s DPH	EUR / bm bez DPH	EUR / bm s DPH
Amore walnut	06389			3,97	4,76		
Nova oak	06413			3,97	4,76		
Casablanca oak	06414			3,97	4,76		
Cracked Terra oak	06439			3,97	4,76		
Light farm oak	06831			3,97	4,76		
Natural farmer's oak	06832			3,97	4,76		
Natural castle oak	06836			3,97	4,76		
Glacier oak	06838			3,97	4,76		
Light castle oak	06841	6,11	7,33	3,97	4,76		
Dark castle oak	06842	6,11	7,33	3,97	4,76		
Light field oak	06843			3,97	4,76		
Natural field oak	06844			3,97	4,76		
Light fjord oak	06846			3,97	4,76		
Greige field oak	06854			3,97	4,76		
Copper iron	06857					4,81	5,77
Dark terrazzo	06858					4,81	5,77
Light terrazzo	06859					4,81	5,77
Madras oak	06891	6,11	7,33	3,97	4,76		
Smoked oak	06893			3,97	4,76		
Greige oak	06934	6,11	7,33	3,97	4,76		
Cognac English oak	06949			3,97	4,76		
Natural English oak	06952	6,11	7,33	3,97	4,76		
Grey wild oak	06977			3,97	4,76		
Natural English oak	06983	6,11	7,33	3,97	4,76		
Pure English oak	06985			3,97	4,76		
Clay grey old wood oak	06986	6,11	7,33	3,97	4,76		
Lakeside oak	06990			3,97	4,76		
Desert oak	06998	6,11	7,33	3,97	4,76		
Golden oak	06999	6,11	7,33	3,97	4,76		
Off-white tower oak	07119			3,97	4,76		
Sand cliff oak	07122			3,97	4,76		
Light princess oak	07123			3,97	4,76		
Nutmeg castle oak	07130			3,97	4,76		
Pure princess oak	07132			3,97	4,76		

Základný materiál (nosič)	Polystyrén	MDF E1	MDF E1
Dĺžka v mm	2 380	2 380	2 380
Počet kusov v balení	4	4	4
Množstvo bm v balení	9,52	9,52	9,52
Uchytávací systém	800000-00001	800000-00001	800000-00001



Pri objednávke vymeňte bodky na konci

čísla produktu s číslicami požadovaného čísla dekoru

(napr. profil 20 PK, Nova oak 06413 = 200013-2380-06413)

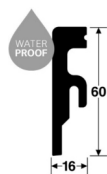

Profil  
20 PK Aqua

200014-2380-...



Profil  
20 PK

200013-2380-...



Profil  
8 PK

200015-2380-...

Názov dekoru	Číslo dekoru	200014-2380-...		200013-2380-...		200015-2380-...	
		EUR / bm bez DPH	EUR / bm s DPH	EUR / bm bez DPH	EUR / bm s DPH	EUR / bm bez DPH	EUR / bm s DPH
Dark princess oak	07134			3,97	4,76		
Grey merino oak	07140			3,97	4,76		
Cosmopolitan stone	07320					4,81	5,77
Concrete	07321					4,81	5,77
Black lava	07323					4,81	5,77
Beach house oak	07326	6,11	7,33	3,97	4,76		
Vintage lodge oak	07327	6,11	7,33	3,97	4,76		
Country garden oak	07329	6,11	7,33	3,97	4,76		
High estate oak	07389	6,11	7,33	3,97	4,76		
Deep grove oak	07390	6,11	7,33	3,97	4,76		
Timber wood	07391	6,11	7,33	3,97	4,76		
Low field oak	07392	6,11	7,33	3,97	4,76		
Arctica oak	07394	6,11	7,33	3,97	4,76		
Springdale oak	07395	6,11	7,33	3,97	4,76		
Hampstead oak	07397	6,11	7,33	3,97	4,76		
Whitebury oak	07398	6,11	7,33	3,97	4,76		
Fleetwood oak	07399	6,11	7,33	3,97	4,76		
Baywood oak	07404	6,11	7,33	3,97	4,76		
Moon dust	07411	6,11	7,33			4,81	5,77
Moon grey	07412	6,11	7,33			4,81	5,77
Moon shadow	07413	6,11	7,33			4,81	5,77
Golden creek oak	07430	6,11	7,33	3,97	4,76		
Natural spring oak	07431	6,11	7,33	3,97	4,76		
Dark cracked Terra oak	07433	6,11	7,33	3,97	4,76		
Cold breeze	07434	6,11	7,33	3,97	4,76		
White cliffs oak	07435	6,11	7,33	3,97	4,76		
Cosmic beam	07436	6,11	7,33			4,81	5,77
Black rock	07437	6,11	7,33			4,81	5,77
Mineral stone	07438	6,11	7,33			4,81	5,77
Cream stone	07439	6,11	7,33			4,81	5,77
White stone	07440	6,11	7,33			4,81	5,77
Harmony oak	07453	6,11	7,33	3,97	4,76		
Natural lakewood oak	07456	6,11	7,33	3,97	4,76		
Lakewood oak	07457	6,11	7,33	3,97	4,76		

Základný materiál (nosič)	Polystyrén	MDF E1	MDF E1
Dĺžka v mm	2 380	2 380	2 380
Počet kusov v balení	4	4	4
Množstvo bm v balení	9,52	9,52	9,52
Uchytávací systém	800000-00001	800000-00001	800000-00001

Pri objednávke vymeňte bodky na konci čísla produktu s číslicami požadovaného čísla dekoru (napr. Profil 10 PK, Plain white gloss DF = 200000-2380-00324)

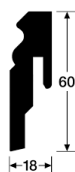

Profil  
10 PK



Profil  
11 PK



Profil  
12 PK



Profil  
13 PK

200000-2380-...

200001-2380-...

200002-2380-...

200003-2380-...

Název dekoru	Číslo dekoru	EUR / bm bez DPH	EUR / bm s DPH	EUR / bm bez DPH	EUR / bm s DPH	EUR / bm bez DPH	EUR / bm s DPH	EUR / bm bez DPH	EUR / bm s DPH
Plain white gloss DF	00324	4,07	<b>4,88</b>	4,53	<b>5,44</b>	4,99	<b>5,99</b>	5,46	<b>6,55</b>
White DF (paintable)	02222	4,07	<b>4,88</b>	4,53	<b>5,44</b>	4,99	<b>5,99</b>	5,46	<b>6,55</b>

Základný materiál (nosič)	MDF E1	MDF E1	MDF E1	MDF E1
Dĺžka v mm	2 380	2 380	2 380	2 380
Počet kusov v balení	4	4	4	4
Množstvo bm v balení	9,52	9,52	9,52	9,52
Uchytávací systém	800000-00001	800000-00001	800000-00001	800000-00001

Zodpovedajúce vnútorné rohy, vonkajšie rohy, spojovacie kusy a koncovky pozri stranu 14 - 17.



Profil  
14 MK

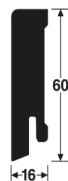

Profil  
15 MK



Profil  
16 MK



Profil  
20 PK

200009-2380-...

200010-2380-...

200011-2380-...

200013-2380-...

Název dekoru	Číslo dekoru	EUR / bm bez DPH	EUR / bm s DPH	EUR / bm bez DPH	EUR / bm s DPH	EUR / bm bez DPH	EUR / bm s DPH	EUR / bm bez DPH	EUR / bm s DPH
Anthracite DF	00059	2,90	<b>3,48</b>	3,38	<b>4,06</b>	3,86	<b>4,64</b>	3,38	<b>4,06</b>
Stainless steel DF	00063	3,48	<b>4,18</b>	3,97	<b>4,76</b>	4,45	<b>5,34</b>	3,97	<b>4,76</b>
Plain white gloss DF	00324	2,77	<b>3,33</b>	3,23	<b>3,88</b>	3,70	<b>4,44</b>	3,23	<b>3,88</b>
White DF (paintable)	02222	2,77	<b>3,33</b>	3,23	<b>3,88</b>	3,70	<b>4,44</b>	3,23	<b>3,88</b>
Black DF	02277							3,38	<b>4,06</b>

Základný materiál (nosič)	MDF E1	MDF E1	MDF E1	MDF E1
Dĺžka v mm	2 380	2 380	2 380	2 380
Počet kusov v balení	4	4	4	4
Množstvo bm v balení	9,52	9,52	9,52	9,52
Uchytávací systém	800000-00003	800000-00003	800000-00003	800000-00001

Zodpovedajúce vnútorné rohy, vonkajšie rohy, spojovacie kusy a koncovky pozri stranu 14 - 17.

Pri objednávke vymeňte bodky na konci čísla produktu s číslicami požadovaného čísla dekoru (napr. Profil 2 PK, Stainless steel DF = 200004-2380-00063)



Profil  
2 PK



Profil  
3 PK

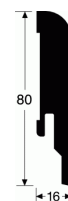

Profil  
5 PK



Profil 6

200004-2380-...

200005-2380-...

200006-2380-...

200007-2380-...

Názov dekoru	Číslo dekoru	EUR / bm bez DPH	EUR / bm s DPH	EUR / bm bez DPH	EUR / bm s DPH	EUR / bm bez DPH	EUR / bm s DPH	EUR / bm bez DPH	EUR / bm s DPH
Stainless steel DF	00063			4,26	5,11				
Plain white gloss DF	00324	3,42	4,11	3,51	4,21	4,26	5,11	1,94	2,32
White DF (paintable)	02222	3,42	4,11	3,51	4,21	4,26	5,11	1,94	2,32

Základný materiál (nosič)	MDF E1	MDF E1	MDF E1	MDF E1
Dĺžka v mm	2 380	2 380	2 380	2 380
Počet kusov v balení	4	4	4	20
Množstvo bm v balení	9,52	9,52	9,52	47,60
Uchytávací systém	800000-00001	800000-00001	800000-00001	800000-00001

Zodpovedajúce vnútorné rohy, vonkajšie rohy, spojovacie kusy a koncovky pozri stranu 14 - 17.

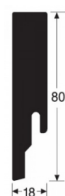

Profil  
9 PK

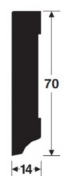

Profil 17



Profil  
18 PK



Profil  
19 PK

200016-2380-...

200012-2380-...

200017-2380-...

200018-2380-...

Názov dekoru	Číslo dekoru	EUR / bm bez DPH	EUR / bm s DPH	EUR / bm bez DPH	EUR / bm s DPH	EUR / bm bez DPH	EUR / bm s DPH	EUR / bm bez DPH	EUR / bm s DPH
Anthracite DF	00059	5,12	6,14						
Stainless steel DF	00063	5,80	6,96						
Plain white gloss DF	00324	4,90	5,87	3,05	3,66	4,16	4,99	5,27	6,32
White DF (paintable)	02222	4,90	5,87	3,05	3,66				
Black DF	02277	5,12	6,14						

Základný materiál (nosič)	MDF E1	MDF E1	MDF E1	MDF E1
Dĺžka v mm	2 380	2 380	2 380	2 380
Počet kusov v balení	4	4	4	4
Množstvo bm v balení	9,52	9,52	9,52	9,52
Uchytávací systém	800000-00001	800000-00001	800000-00001	800000-00001

Zodpovedajúce vnútorné rohy, vonkajšie rohy, spojovacie kusy a koncovky pozri stranu 14 - 17.

Pri objednávke vymeňte body na konci čísla produktu s číslicami požadovaného čísla dekoru (napr. Profil 2 PK, Stainless steel DF = 200004-2380-00063)

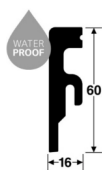

Profil  
20 PK AQUA



Profil  
8 PK



Profil 7

200014-2380-...

200015-2380-...

200008-2380-...

Názov dekoru	Číslo dekoru	EUR / bm bez DPH	EUR / bm s DPH	EUR / bm bez DPH	EUR / bm s DPH	EUR / bm bez DPH	EUR / bm s DPH
Anthracite DF	00059			3,97	<b>4,76</b>		
Stainless steel DF	00063	6,38	<b>7,66</b>	4,74	<b>5,69</b>		
Plain white gloss DF	00324	5,54	<b>6,65</b>	3,80	<b>4,55</b>	1,94	<b>2,32</b>
White DF (paintable)	02222			3,80	<b>4,55</b>		
Black DF	02277			3,97	<b>4,76</b>	1,94	<b>2,32</b>

Základný materiál (nosič)	Polystyren	MDF E1	MDF E1
Dĺžka v mm	2 380	2 380	2 380
Počet kusov v balení	4	4	4
Množstvo bm v balení	9,52	9,52	9,52
Uchytávací systém	800000-00001	800000-00001	

Zodpovedajúce vnútorné rohy, vonkajšie rohy, spojovacie kusy a koncovky pozri stranu 14 - 17.

## Vnútorné rohy, vonkajšie rohy a koncovky

Zladené komponenty pre  
profil lišty 2 PK

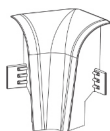

Vnútorný roh



Vonkajší roh



Ukončenie

800027-01-02001

800027-02-02001

800027-03-02001

Názov dekoru	Číslo dekoru	EUR / bal. bez DPH	EUR / bal. s DPH	EUR / bal. bez DPH	EUR / bal. s DPH	EUR / bal. bez DPH	EUR / bal. s DPH
White 02001	02001	7,30	<b>8,76</b>	5,27	<b>6,32</b>	5,27	<b>6,32</b>
Základný materiál (nosič)		ABS		ABS		ABS	
Počet kusov v balení		4		2		1 ľavé + 1 pravé	

## Vnútorne rohy, vonkajšie rohy a koncovky

Zladené komponenty pre  
profil lišty 3 PK

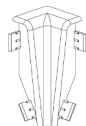

Vnútorný roh



Vonkajší roh



Ukončenie

Názov dekoru	Číslo dekoru	EUR / bal.	EUR / bal.	EUR / bal.	EUR / bal.	EUR / bal.	EUR / bal.
		bez DPH	s DPH	bez DPH	s DPH	bez DPH	s DPH
		<b>7,30</b>	<b>8,76</b>	<b>5,27</b>	<b>6,32</b>	<b>5,27</b>	<b>6,32</b>
White 02001	02001	800015-01-02001		800015-02-02001		800015-03-02001	
Stainless steel look 02002	02002	800015-01-02002		800015-02-02002		800015-03-02002	
Maple 02009	02009	800015-01-02009		800015-02-02009		800015-03-02009	
Beech 02011	02011	800015-01-02011		800015-02-02011		800015-03-02011	
Natural oak 02013	02013	800015-01-02013		800015-02-02013		800015-03-02013	
White oak 02014	02014	800015-01-02014		800015-02-02014		800015-03-02014	
Light walnut 02017	02017	800015-01-02017		800015-02-02017		800015-03-02017	
Light oak 02034	02034	800015-01-02034		800015-02-02034		800015-03-02034	
Základný materiál (nosič)		ABS		ABS		ABS	
Počet kusov v balení		4		2		1 ľavé + 1 pravé	

## Aké príslušenstvo soklovej lišty použiť

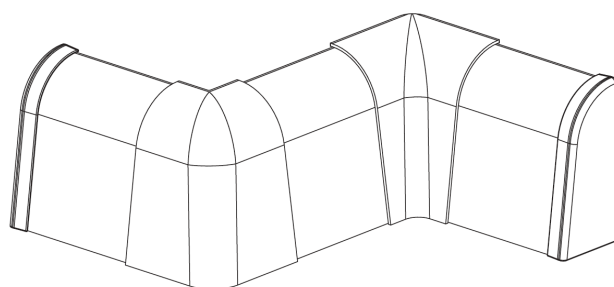
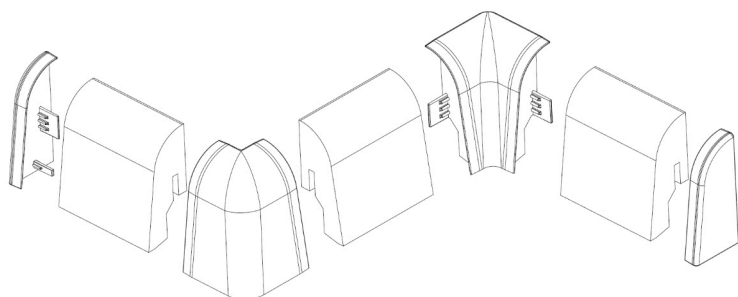

Maple 02009	Maple 00202
Beech 02011	Beech 06201
Light oak 02034	Light cracked oak 06258 / Distinctive pure oak 06273 / Light Chiemsee oak 06376 / Taverna oak 06428 / Light field oak 06843 / Madras oak 06891 / Pure princess oak 07132 / Natural lakewood oak 07456 / Lakewood oak 07457
Natural oak 02013	Oak 06064 / Natural castle oak 06836 / Hazelbrook oak 07013 / Fleetwood oak 07399
White oak 02014	White lyed oak 06181 / Marzipan oak 06268
Light walnut 02017	Walnut 00211 / Amore walnut 06389 / Walnut 06440

## Vnútorne rohy, vonkajšie rohy a koncovky



Vnútorný roh  
(samolepiaci)

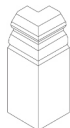

Vonkajší roh  
(samolepiaci)

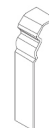

Spojka  
(samolepiaca)

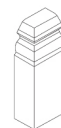

Ukončenie  
(samolepiace)

Zodpovedajúce profilom: 10 PK I 10 F MK (60 mm)	EUR / bal.	EUR / bal.	EUR / bal.	EUR / bal.	EUR / bal.	EUR / bal.	EUR / bal.	EUR / bal.	EUR / bal.
	bez DPH	s DPH	bez DPH	s DPH	bez DPH	s DPH	bez DPH	s DPH	bez DPH
	7,30	8,76	5,27	6,32	5,27	6,32	5,27	6,32	5,27
White 02001	800028-01-02001		800028-02-02001		800028-04-02001		800028-03-02001		

Zodpovedajúce profilom: 11 MK I 1 F MK (80 mm)	EUR / bal.	EUR / bal.	EUR / bal.	EUR / bal.	EUR / bal.	EUR / bal.	EUR / bal.	EUR / bal.	EUR / bal.
	bez DPH	s DPH	bez DPH	s DPH	bez DPH	s DPH	bez DPH	s DPH	bez DPH
	7,30	8,76	5,27	6,32	5,27	6,32	5,27	6,32	5,27
White 02001	800029-01-02001		800029-02-02001		800029-04-02001		800029-03-02001		

Zodpovedajúce profilom: 12 PK I 12 F MK (100 mm)	EUR / bal.	EUR / bal.	EUR / bal.	EUR / bal.	EUR / bal.	EUR / bal.	EUR / bal.	EUR / bal.	EUR / bal.
	bez DPH	s DPH	bez DPH	s DPH	bez DPH	s DPH	bez DPH	s DPH	bez DPH
	8,23	9,87	5,92	7,10	5,92	7,10	5,92	7,10	5,92
White 02001	800030-01-02001		800030-02-02001		800030-04-02001		800030-03-02001		

Zodpovedajúce profilom: 13 PK (120 mm)	EUR / bal.	EUR / bal.	EUR / bal.	EUR / bal.	EUR / bal.	EUR / bal.	EUR / bal.	EUR / bal.	EUR / bal.
	bez DPH	s DPH	bez DPH	s DPH	bez DPH	s DPH	bez DPH	s DPH	bez DPH
	8,23	9,87	5,92	7,10	5,92	7,10	5,92	7,10	5,92
White 02001	800031-01-02001		800031-02-02001		800031-04-02001		800031-03-02001		

Základný materiál (nosič)	ASA	ASA	ASA	ASA
Počet kusov v balení	4	2	2	1 ľavé + 1 pravé

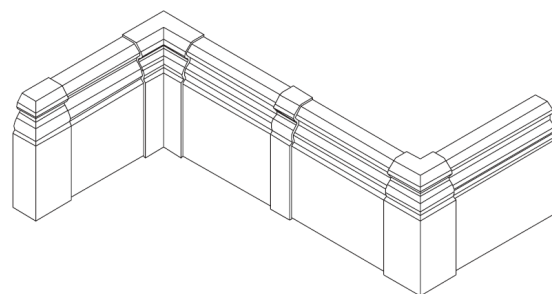
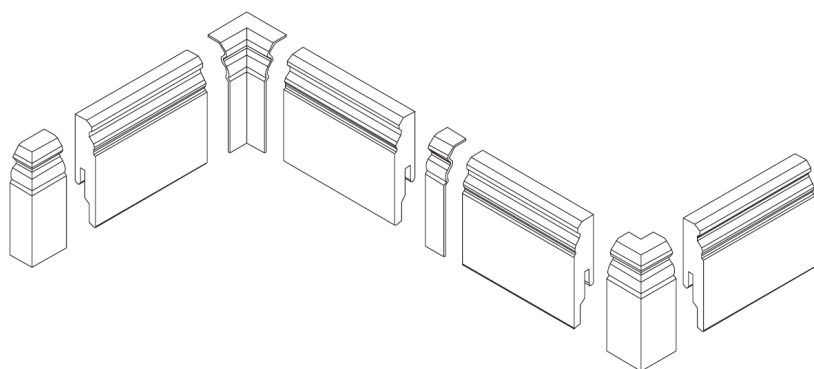

## Vnútorne rohy, vonkajšie rohy a koncovky

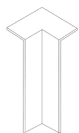

Vnútorný roh  
(samolepiaci)



Vonkajší roh  
(samolepiaci)



Spojka  
(samolepiaca)



Ukončenie  
(samolepiace)

Zodpovedajúce profilom: 8 PK I 18 PK (50 mm)	EUR / bal.	EUR / bal.	EUR / bal.	EUR / bal.	EUR / bal.	EUR / bal.	EUR / bal.	EUR / bal.	EUR / bal.
	bez DPH	s DPH	bez DPH	s DPH	bez DPH	s DPH	bez DPH	s DPH	bez DPH
	7,30	8,76	5,27	6,32	5,27	6,32	5,27	6,32	5,27
White 02001	800032-01-02001		800032-02-02001		800032-04-02001		800032-03-02001		

Zodpovedajúce profilom: 9 PK I 19 PK (80 mm)	EUR / bal.	EUR / bal.	EUR / bal.	EUR / bal.	EUR / bal.	EUR / bal.	EUR / bal.	EUR / bal.	EUR / bal.
	bez DPH	s DPH	bez DPH	s DPH	bez DPH	s DPH	bez DPH	s DPH	bez DPH
	7,30	8,76	5,27	6,32	5,27	6,32	5,27	6,32	5,27
White 02001	800033-01-02001		800033-02-02001		800033-04-02001		800033-03-02001		

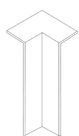

Vnútorný roh  
(samolepiaci)



Vonkajší roh  
(samolepiaci)



Spojka  
(samolepiaca)



Ukončenie  
(samolepiace)

Zodpovedajúce profilom: 15 MK I 15 F MK 20 PK I 20 PK Aqua	EUR / bal.	EUR / bal.	EUR / bal.	EUR / bal.	EUR / bal.	EUR / bal.	EUR / bal.	EUR / bal.	EUR / bal.
	bez DPH	s DPH	bez DPH	s DPH	bez DPH	s DPH	bez DPH	s DPH	bez DPH
	7,30	8,76	5,27	6,32	5,27	6,32	5,27	6,32	5,27
White 02001	800034-01-02001		800034-02-02001		800034-04-02001		800034-03-02001		
Stainless steel look 02038	800034-01-02038		800034-02-02038		800034-04-02038		800034-03-02038		
Black 02039	800034-01-02039		800034-02-02039		800034-04-02039		800034-03-02039		

Základný materiál (nosič)	ASA	ASA	ASA	ASA
Počet kusov v balení	4	2	2	1 ľavé + 1 pravé

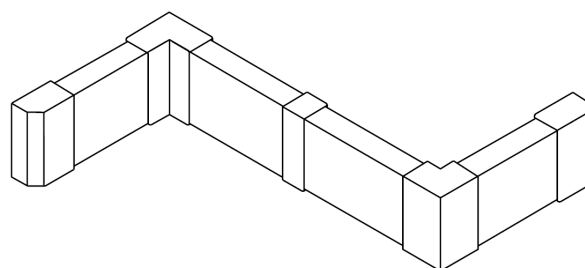
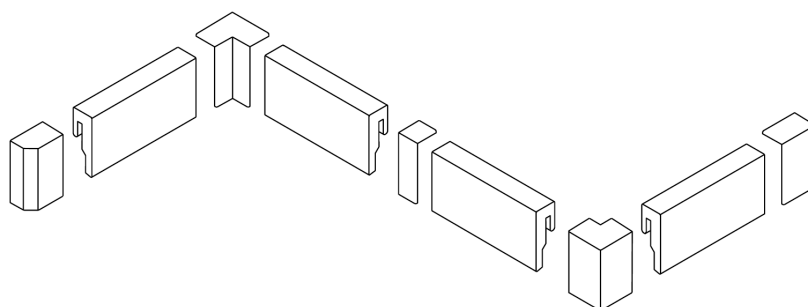

## Originálne podložky pod podlahy

Kód produktu	Názov produktu	Rozmer (mm)	Balenie (m <sup>2</sup> )	EUR / m <sup>2</sup> bez DPH	EUR / m <sup>2</sup> s DPH
800014-00004	MEISTER-Silence 25 dB	3,0 x 1000 x 5500	5,5	8,79	<b>10,55</b>

PUR, integrovaná parozábrana + Alu strip; útlm kročajového hluku 19 dB; priestor -31%; tlaková stabilita cca. 130kPa

800014-00005	MEISTER-Silence 20	2,5 x 1000 x 7000	7,0	6,00	<b>7,20</b>
--------------	--------------------	-------------------	-----	------	-------------

PUR-minerálna zmes; útlm kročajového hluku 19 dB; útlm priestorovej hlučnosti -28%; tlaková stabilita cca. 150kPa

800014-00006	MEISTER-Silence 15	2,0 x 1000 x 8500	8,5	5,73	<b>6,88</b>
--------------	--------------------	-------------------	-----	------	-------------

PUR, integrovaná parozábrana + Alu strip; útlm kročajového hluku 18 dB; priestor -25%; tlaková stabilita cca. 220kPa

800014-00008	MEISTER-Silence Compact	1,5 x 1000 x 10000	10,0	7,04	<b>8,45</b>
--------------	-------------------------	--------------------	------	------	-------------

Hrúbka 1,5 mm, vyrobená z PUR minerálnej zmesi určená k inštalácii plávajúcich dizajnových, rigidných a celovinylových podláh s klik systémom. Pevnosť v tlaku (hodnota CS): cca. 450 kPa Zníženie kročajového hluku: až 18 dB

800014-00010	MEISTER-SilenceEco VPE	3,0 x 590 x 790	9,322	2,63	<b>3,15</b>
--------------	------------------------	-----------------	-------	------	-------------

Tlakovo stabilná podložka z drevovlákná; útlm kročajového hluku 18 dB; tlaková stabilita cca. 150kPa

800014-00012	MEISTER-Twin Control foam	2,0 x 1000 x 25000	25,0	4,16	<b>4,99</b>
--------------	---------------------------	--------------------	------	------	-------------

Penová podložka s integrovanou parozábranou; útlm kročajového hluku 19 dB; priestor -15%; tlaková stabilita cca. 60kPa



800014-00001	MEISTER-Alu-Strip	0,2 x 50 x 50000	50,0	8,29	<b>9,95</b>
--------------	-------------------	------------------	------	------	-------------

Alumíniová lepiaca páska na zlepenie pásov podložky Meister-Twin Control

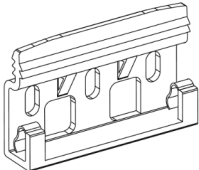

Kód produktu	Názov produktu	Materiál	EUR bez DPH	EUR s DPH
800001-00003	Meister tension rod - uťahovák posledného radu	ocel'	23,94	<b>28,72</b>
800001-00013	Tapping block 5 mm (inštalačný blok)	plast	9,26	<b>11,11</b>
800001-00010	Tapping block In&Out 7 mm (inštalačný blok)	plast	7,30	<b>8,76</b>
800001-00007	Drevené dištančné klíny	drevo	4,90	<b>5,87</b>
800001-00008	Upevňovací klin (ocel' + drevo)	ocel'/drevo	12,85	<b>15,42</b>

## Uchytávacie klipy

Kód produktu	Obrázok	Názov produktu	Balenie (ks / bal.)	Spotreba (ks / bm)	MOC /bal. bez DPH	MOC /bal. s DPH
800000-00001		Uchytávacie klipy pre soklové lišty 2 PK, 3 PK, 5 PK, 8 PK, 9 PK, 10 PK, 11 PK, 12 PK, 13 PK, 18 PK, 19 PK, 20 PK a 20 PK Aqua	50 / bal.	50 klipov na 20 bm lišty	11,92	<b>14,31</b>
800000-00003		Uchytávacie klipy pre soklové lišty 10 F MK, 11 F MK, 12 F MK, 14 MK, 14 F MK, 15 MK, 15 F MK, 16 MK, 21 F MK, 22 F MK, 23 F MK	50 / bal.	50 klipov na 20 bm lišty	14,70	<b>17,64</b>

## Radiatorové rozery z masívneho dreva

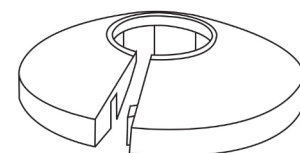
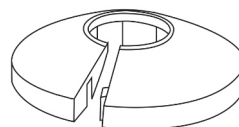

Vnútorný priemer

Ø 15 mm

Ø 18 mm

Ø 22 mm

Vonkajší priemer

Ø 50 mm

Ø 50 mm

Ø 55 mm

Názov dekoru	Číslo dekoru	MOC /bal. bez DPH	MOC /bal. s DPH	MOC /bal. bez DPH	MOC /bal. s DPH	MOC /bal. bez DPH	MOC /bal. s DPH
		6,01	<b>7,21</b>	6,01	<b>7,21</b>	6,01	<b>7,21</b>
Oak 00001	00001	800002-15-00001		800002-18-00001		800002-22-00001	
Beech 00019	00019	800002-15-00019		800002-18-00019		800002-22-00019	
		6,66	<b>7,99</b>	6,66	<b>7,99</b>	6,66	<b>7,99</b>
Walnut 00015	00015	800002-15-00015		800002-18-00015		800002-22-00015	

## Radiatorové rozery plastové

Kód produktu	Názov produktu	Balenie	EUR bez DPH	EUR s DPH
800002-00-02009	Maple 02009 (wood effect)	2 ks	7,30	<b>8,76</b>
800002-00-02011	Beech 02011 (wood effect)	2 ks	7,30	<b>8,76</b>
800002-00-02013	Natural oak 02013 (wood effect)	2 ks	7,30	<b>8,76</b>
800002-00-02014	White oak 02014 (wood effect)	2 ks	7,30	<b>8,76</b>
800002-00-02017	Walnut 02017 (wood effect)	2 ks	7,30	<b>8,76</b>
800002-00-02034	Light oak 02034 (wood effect)	2 ks	7,30	<b>8,76</b>
800002-00-02035	Chrome 02035 (decor)	2 ks	7,30	<b>8,76</b>
800002-00-02043	White 02043 (decor)	2 ks	7,30	<b>8,76</b>

Vnútorý priemer	Ø 15   18   22 mm
Vonkajší priemer	Ø 50 mm
Materiál	ABS

## Zladené radiatorové rozery s laminátovými a diajnovými podlahami MEISTER

Mapple 02009	Maple 02009
Beech 02011	Beech 06201
Light oak 02034	Light cracked oak 06258 / Marrakech oak 06396 / Casablanca oak 06414 / Taverna oak 06428 / Bayfield oak 06679 / Light castle oak 06841 / Sand princess oak 06895 / Kingdom oak 06899 / Caramel oak 06953 / Champagne oak 07001 / Pure relax oak 07113 / Cream tower oak 07120 / Toffee oak 07142 / Light valley oak 07144 / Pure fountain oak 07152
Natural oak 02013	Oak 00462 / Natural oak 06067 / Oak 06443 / East coast oak 06682 / Natural farmer's oak 06832 / Hazelbrook oak 07013 / Woodend oak 07014 / Villa oak 07016 / Steamed riverbank oak 07116 / Natural riverbank oak 07117 / Nevado oak 07147 / Chianti oak 07149 / Hill oak 07153
White oak 02014	White lyed oak 06181 / Marzipan oak 06268 / Atacama oak 06380 / Off-white tower oak 07119 / Sand cliff oak 07122 / White mountain oak 07124 / White riverbank oak 07126
Walnut 02017	Walnut 00211 / Amore walnut 06389 / Walnut 06440 / Muscat oak 06416 / Dark fountain oak 07111

## Údržba - čistenie

Kód produktu	Názov produktu	Balenie	EUR bez DPH	EUR s DPH
800021-00001-A17	Dr.Schutz Laminate Reiniger 750ml (DE ver.)	1 ks	9,06	<b>10,88</b>
800021-00002-A22	Dr.Schutz Laminate Cleaner 750ml (EN ver.)	1 ks	9,06	<b>10,88</b>

Vhodné na bežné čistenie všetkých laminátových podláh MEISTER a Nadura. Odstraňuje nečistoty, masťotu a šmuhy od podrážok topánok. Čistí jemne, ale dôkladne. Obsah: 750 ml. Balenie: plastová fľaša - koncentrát).

Kód produktu	Názov produktu	Balenie	EUR bez DPH	EUR s DPH
800021-00019-A17	Dr.Schutz Elatex universal 200ml (DE ver.)	1 ks	10,08	<b>12,09</b>
800021-00019-A17	Dr.Schutz Elatex universal 200ml (EN ver.)	1 ks	10,08	<b>12,09</b>

Dr. Schutz-Elatex univerzálny odstraňovač škvŕn - odstraňuje šmuhy od podrážok topánok a odolné nečistoty. Balenie: plastová fľaša s rozprašovačom. Pripravené k aplikácii.